

Thank you for choosing

Panasonic Omnivision **VHS**

Video Cassette Recorder

MODEL PV-8665S

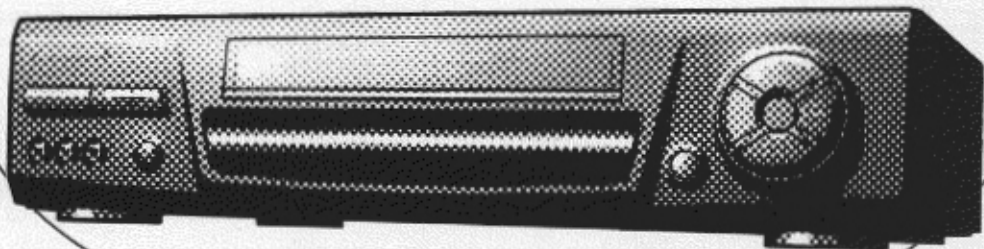

Operating Instructions



As an ENERGY STAR® Partner, Matsushita Electric Corporation of America has determined that this product or product model meets the ENERGY STAR® guidelines for energy efficiency.

Please read these instructions carefully before attempting to connect, operate or adjust this product. Please save this manual.

Spanish Quick Use Guide is included. (Guía para rápida consulta en español está incluida.)

Quick Use Guide is on the back cover.

P6 ~ P9
Connections

P10 ~ P18
Getting Started

P19 ~ P23
Basic Operation

P24 ~ P37
More You Can Do

P38 ~ Back Cover
Other Information

Things You Should Know

Congratulations

on your purchase of one of the most sophisticated and reliable products on the market today. Used properly, it will bring you and your family years of enjoyment. Please fill in the information at right. The serial number is on the tag located on the back of your VCR.

Date of Purchase _____
 Dealer Purchased From _____
 Dealer Address _____
 Dealer Phone No. _____
 Model No. **PV-8665S** _____
 Serial No. _____

Safety Precautions

Warning: To prevent fire or shock hazard, do not expose this equipment to rain or moisture. This video recorder, equipped with the HQ (High Quality) System, is compatible with existing VHS equipment. Only use those tapes with the **VHS** mark. It is recommended that only cassette tapes that have been tested and inspected for use in 2, 4, 6, and 8 hour VCR machines be used.

FCC Warning: Any unauthorized changes or modifications to this equipment would void the user's authority to operate.

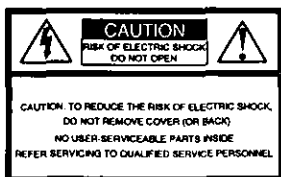

This symbol warns the user that uninsulated voltage within the unit may have sufficient magnitude to cause electric shock. Therefore, it is dangerous to make any kind of contact with any inside part of this unit.



This symbol alerts the user that important literature concerning the operation and maintenance of this unit has been included. Therefore, it should be read carefully in order to avoid any problems.

Table of Contents

Important Safeguards and Precautions	3
Unpacking Your VCR • Product Features	4
VCR and Cassette Information (Record Tab, Tape Speeds, Head Cleaning, DST., Specifications)	5

Connections

Basic Connection (Antenna and VCR, VCR and TV)	6, 7
Other Connections (CABLE, Audio/Video)	8, 9

Getting Started

Location of Controls (Remote Control, VCR)	10, 11
One Time VCR Setup (On-Screen Language, Cable Box/ DSS Receiver Setup, Channel Memory, Auto Clock Set) ..	12 ~ 17
On-Screen Displays (OSD) (Function, Channel, Menu, VCR Status & Clock, Warning)	18

Basic Operation

Playback a Tape (Main Operation, Special Effects, Quality Picture Features)	19
Record On a Tape (Main Operation, One Touch Record, Select Input Mode, Channel Selection)	20, 21
Timer Recording (Main Operation, Cancel, Clear or Replace Program Contents)	22, 23

More You Can Do

Tape Operation (Index Search, Repeat Play, One Minute Skip, Zero Search, Auto Functions)	24 ~ 26
Special VCR Features (VCR Lock, Warning Beeper, Channel Caption, Time Stamp, Blue Back ON/OFF) ..	27 ~ 30
Copying Your Tapes (Dubbing) (Connection, Main Operation, Monitoring)	31
MTS Broadcast/ VHS Hi-Fi Stereo System (Stereo/SAP/Mono Broadcast, Select Audio Mode)	32, 33
VCR Plus+ Setup (VCR Plus+ Channel Setup)	34
VCR Plus+ Programming (Main Operation, Make Correction)	35
Multi-Brand Control Feature	36, 37

Other Information

Before Requesting Service (Self-check items)	38
Warranty	39
Spanish Quick Use Guide	40 ~43
Quick Use Guide	Back Cover



Important Safeguards and Precautions

FOR YOUR SAFETY, READ AND RETAIN ALL SAFETY AND OPERATING INSTRUCTIONS. HEED ALL WARNINGS IN THE MANUAL AND ON THE UNIT

INSTALLATION

1 POWER SOURCE CAUTION

Operate only from a power source indicated on the unit or in this manual. If necessary, have your Electric Utility Service Company or Video Products Dealer verify the power source in your home.

2 POLARIZED OR GROUNDING PLUG

As a safety feature, this Video product comes with either a polarized power cord plug (one blade is wider than the other), or a three-wire grounding type plug.

POLARIZED PLUG CAUTION:

This plug will only fit into an outlet one way. If you cannot fully insert the plug, try reversing it. If it still will not fit, have an electrician install the proper wall outlet. Do not defeat the safety feature by tampering with the plug.

GROUNDING PLUG CAUTION:

This plug will only fit into a three-hole grounding outlet. If necessary, have an electrician install the proper outlet. Do not defeat the safety feature by tampering with the plug.

3 POWER CORD

Make sure power cords are routed so that they are not likely to have anything rest on them, roll over them, or be in the way of walking traffic.

If an extension cord is used, make sure it also has either a polarized or grounded plug and that the cords can be securely connected.

Frayed cords, damaged plugs, and damaged or cracked wire insulation are hazardous and should be replaced by a qualified service technician.

Overloaded outlets and extension cords are fire hazards and should be avoided.

4 DO NOT BLOCK VENTILATION HOLES

Ventilation openings in the cabinet release heat generated during operation. If they are blocked, heat build-up inside the unit can cause failures that may result in a fire hazard or heat damage to cassettes.

For protection, follow these rules:

- Never cover ventilation slots or the unit while in use, or operate the unit when placed on a bed, sofa, rug, or other soft surface.
- Avoid built-in installation, such as a book case or rack, unless proper ventilation is provided.

5 AVOID EXTREMELY HOT LOCATIONS OR SUDDEN TEMPERATURE CHANGES

Do not place the unit over or near any kind of heater or regulator, in direct sunlight, inside a closed vehicle, etc..

Do not move the unit suddenly between areas of extreme temperature variation. If the unit is suddenly moved from a cold place to a warm place, moisture may condense in the unit and on the tape.

6 TO AVOID PERSONAL INJURY

- Do not place unsecured equipment on a sloping surface.
- Do not place this unit on any support that is not firm, level, and adequately strong. The unit could fall causing serious injury to a child or adult and damage to the unit.
- An appliance and cart combination should be moved with care. Quick stops, excessive force, and uneven surfaces may cause the appliance and cart combination to overturn.
- Carefully follow all operating instructions and use the manufacturer's recommended accessories when operating this unit or connecting it to any other equipment.



OUTDOOR ANTENNA INSTALLATION

1 SAFE ANTENNA AND CABLE CONNECTION

If an outside antenna or cable system is connected to the equipment, be sure the antenna or cable system is grounded so as to provide some protection against built up static charges and voltage surges.

Section 810 of the National Electrical Code, ANSI/NFPA 70 (in Canada, part 1 of the Canadian Electrical Code) provides information with respect to proper grounding of the mast and supporting structure, grounding of the lead-in wire to an antenna discharge unit, size of grounding conductors, location of antenna discharge unit, connection to grounding electrodes and requirements for the grounding electrode.

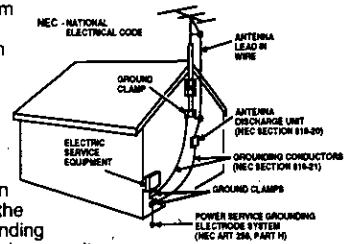

2 KEEP ANTENNA CLEAR OF HIGH VOLTAGE POWER LINES OR CIRCUITS

An outside antenna system should be located well away from power lines, electric light or power circuits and where it will never come into contact with these power sources if it should happen to fall. When installing an outside antenna, extreme care should be taken to avoid touching power lines, circuits or other power sources as this could be fatal. Because of the hazards involved, antenna installation should be left to a professional.

USING THE VIDEO UNIT

If the unit has been in storage or moved to a new location, refer first to the INSTALLATION section of these safeguards.

1 KEEP THIS VIDEO UNIT AWAY FROM WATER OR MOISTURE OF ANY KIND.

2 IF EQUIPMENT IS EXPOSED TO RAIN, MOISTURE, OR STRONG IMPACT, unplug the unit and have it inspected by a qualified service technician before use.

3 DURING AN ELECTRICAL STORM

During a lightning storm, whether indoors or outdoors, or before leaving the unit unused for extended periods of time, disconnect all equipment from the power source as well as the antenna and cable system.

4 WHEN THE UNIT IS PLUGGED IN

- Never expose the unit to rain or water. DO NOT OPERATE if liquid has been spilled into the unit. Immediately unplug the unit, and have it inspected by a service technician. Fire and shock hazards can result from electrical shorts caused by liquid contact inside.
- Never drop or push any object through openings in the unit. Some internal parts carry hazardous voltages and contact can cause electric shock or fire hazard.
- Avoid placing the unit directly above or below your TV set as this may cause electrical interference. Keep all magnets away from electronic equipment.

5 USING ACCESSORIES

Use only accessories recommended by the manufacturer to avoid risk of fire, shock, or other hazards.

6 CLEANING THE UNIT

Unplug the unit. Then, use a clean, dry, chemically untreated cloth to gently remove dust or debris. DO NOT USE cleaning fluids, aerosols, or forced air that could over-spray, or seep into the unit and cause electrical shock. Any substance such as wax, adhesive tape, etc. may mar the cabinet surface. Exposure to greasy, humid, or dusty areas may adversely affect internal parts.

SERVICE

1 DO NOT SERVICE THIS PRODUCT YOURSELF

If, after carefully following the detailed operating instructions, this Video product does not operate properly, do not attempt to open or remove covers, or make any adjustments not described in the manual. Unplug the unit and contact a qualified service technician.

2 IF REPLACEMENT PARTS ARE REQUIRED

Make sure the service technician uses only parts specified by the manufacturer, or those having the same safety characteristics as the original parts. The use of unauthorized substitutes may result in fire, electric shock, or other hazards.

3 HAVE THE SERVICE TECHNICIAN PERFORM A SAFETY CHECK

After any service or repairs to the unit, request the service technician to conduct a thorough safety check as described in the manufacturer's service literature to insure that the video unit is in safe operating condition.

Unpacking Your VCR • Product Features

Unpacking Your VCR

The accessories below are provided to help you use or set up your VCR.

Accessories

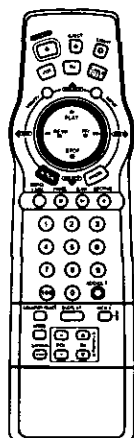

Light Tower™ Universal Remote Control VSQS1578

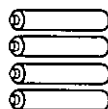

4 "AA" Batteries



RF Coaxial Cable VJAS0196

To order accessories, call toll free 1-800-211-PANA (7262).

Loading the Batteries

1 Press down on the mark and slide the Battery Compartment lid open.

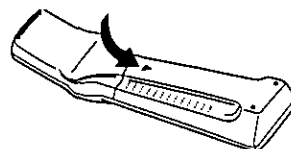

2 Install four batteries as indicated inside the Battery Compartment.

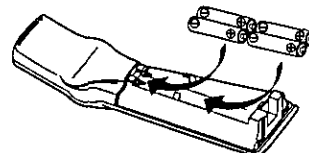

3 Slide the Battery Compartment lid back into place.

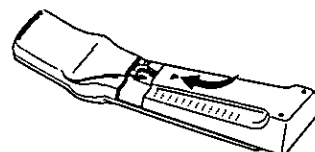

Battery replacement caution

- Do not mix old and new batteries.
- Do not mix alkaline with manganese batteries.

Product Features

All Channel Auto Set/ 181-CH TV/ CABLE Tuner.....	14 ~ 16
Auto Clock Set	14 ~ 16
Auto Daylight Saving Time	5
Auto Features for a Quality Picture	19
Auto Operation Functions (Auto Playback, Rewind, Tape Eject, Power off).....	26
Auto Repeat Function	26
Cable Box Channel Control	13
Digital Auto Picture	19
Easy-to-Read English/ Spanish/ French On-Screen Displays	14 ~ 16, 22, 23
Front-mounted A/V In Terminals	31
Head Cleaner	5
Light Tower™ Universal Remote Control	10
MTS Broadcast System (Multi-channel Television Sound-Stereo, SAP, Mono)	32
Multi Brand TV/ Cable Box/ DSS Remote Control	36, 37
One Minute Skip	26
One Month, 8 Program Timer Recording	22, 23
One Touch Recording (OTR)	20
Program Director Remote Control	22, 23
Special Effects Playback.....	19
Special VCR Features (VCR Lock, Warning Beeper, Channel Caption, Time Stamp, Blue Back ON/OFF)	27 ~ 30
Timer Recording Using VCR Buttons	23
VCR Plus+ Recording	34, 35
VHS Hi-Fi Stereo System	33
VHS Index Search System (Direct Access Search, Program Index Search, Index Scan Search)	24, 25
Zero Search	26

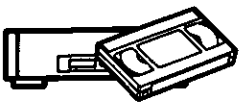

VCR and Cassette Information

Erase Protection (Record Tab)

Cassettes have a record tab to ensure that recordings are not accidentally erased.

To prevent accidental erasure, break off the tab with a screwdriver.



To record again, cover the hole with cellophane tape.



Maximum Record/Playback Time

Only use tapes with the **VHS** mark in this unit.

Tape Speed Setting	Type of Video Cassette		
	T60	T120	T160
SP (Standard Play)	1 Hour	2 Hours	2 Hours 40 Minutes
LP (Long Play)	2 Hours	4 Hours	5 Hours 20 Minutes
SLP (Super Long Play)	3 Hours	6 Hours	8 Hours

Build-in Head Cleaner

A clean video head helps produce a clear picture. So, we have equipped your VCR with a built-in, non chemical head cleaning system that helps prevent clogging of the video heads. Cleaning is performed each time you load or unload a video cassette.

Note: This feature is preventative only. If your video heads are seriously clogged, consider the use of a chemical nonabrasive head cleaning kit or take your VCR to a Service Center.

Head Cleaning

Your VCR will not normally require head cleaning, however, the heads may become clogged when playing an old or damaged tape.

Video Heads Sensor System

If head cleaning becomes necessary, the VCR will display the screen shown to the right while playing back a Video Tape. To exit this screen, push PLAY on the remote control or VCR.

VIDEO HEADS MAY
NEED CLEANING
PLEASE INSERT HEAD
CLEANING CASSETTE
OR REFER TO MANUAL

END:PLAY KEY

- Use "dry" type head cleaning cassette* only.
- Be sure to follow the cleaning tape instructions carefully. Excessive use of a cleaning cassette can shorten head life.
- If using a head cleaning cassette does not solve the problem, contact your nearest Factory Service Center or authorized Service Center.

* Cleaning cassette part No. NV-TCL30PT is recommended.

Reset all VCR Memory Functions

Use when moving the VCR to a new location, or if a mistake was made in the One Time VCR Setup section.

- Make sure a tape is not inserted in the VCR.
- 1) Turn VCR Power on.
 - 2) Press and hold both PLAY and CHANNEL ▲ on the VCR for more than 5 seconds.
 - The power will shut off.
 - 3) Perform the One Time VCR Setup section on page 14.

D.S.T. (Daylight Saving Time)

Your VCR can be set to automatically adjust the clock for Daylight Saving Time. (Page 16.)

Spring (First Sunday in April)

When set to DST:ON, the VCR will automatically set the clock ahead one hour.

Autumn (Last Sunday in October)

When set to DST:ON, the VCR will automatically set the clock back one hour.

- If your area does not observe Daylight Saving Time, select DST:OFF.
- Keep these time changes in mind when programming the VCR for timer recordings.

Specifications

Power Source:	120V AC, 60 Hz
Power Consumption:	Approx. 23 watts (Power on) Approx. 3.7 watts (Power off)
Video Signal:	EIA Standard NTSC color
Video Recording System:	4 rotary heads helical scanning system
Audio Track:	1 track (Normal) 2 channel (Hi-Fi Audio Sound)
Tuner:	VHF 2-13, UHF 14-69
Broadcast Channels:	Midband A through I (14-22)
CABLE Channels:	Superband J through W (23-36) Hyperband AA-EEE (37-64) Lowband A-5-A-1 (95-99) Special CABLE channel 5A (01) Ultraband 65-94, 100-125
Operating Temperature:	41°F-104°F (5°C-40°C)
Operating Humidity:	10%-75%
Weight:	7.7 lbs. (3.5 kg)
Dimensions:	16-15/16" (W) x 7-13/16" (H) x 11-13/16" (D) 430 (W) x 98 (H) x 300 (D) mm

Note: Designs and specifications are subject to change without notice.



Basic Connection

ANTENNA

INDOOR ANTENNA

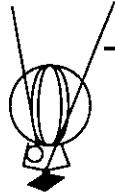

or

OUTDOOR ANTENNA

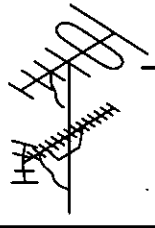

or

Cable TV

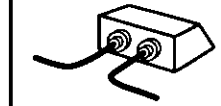

1 Disconnect the antenna or cable from your TV and connect it to the VCR (IN FROM ANT.)

VCR

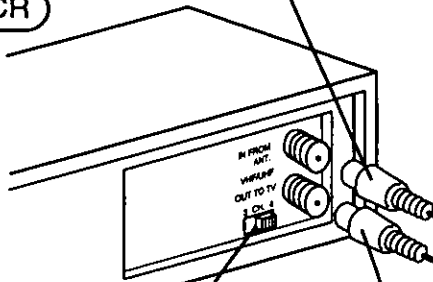

Antenna Cable

TV

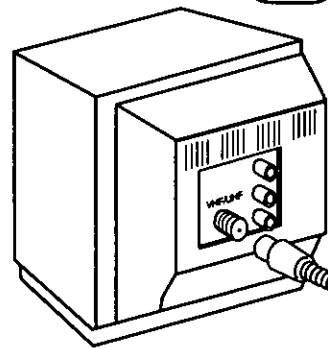

3 Set the Output Channel of your VCR to channel 3 or 4 (whichever is not being transmitted on by a Local TV broadcast).

2 Connect the VCR to your TV with the RF Coaxial Cable (OUT TO TV).

RF Coaxial Cable (VCR-TV Connection Cable) (supplied)

WARNING

When using "Nut type" RF coaxial cables, tighten with fingers only. Overtightening may damage terminals.

Between Antenna and VCR

Case 1: Twin Lead Cable Only

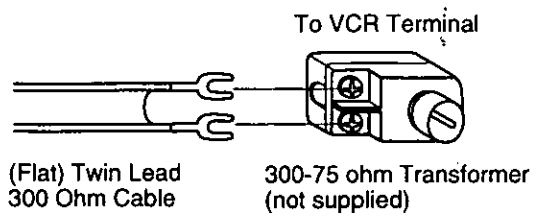

Case 2: Twin Lead & Coaxial Cables

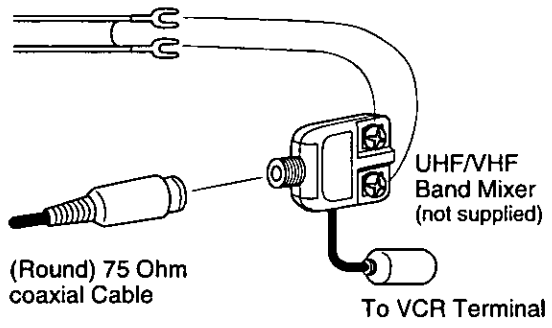

Case 3: Two Twin Lead Cables

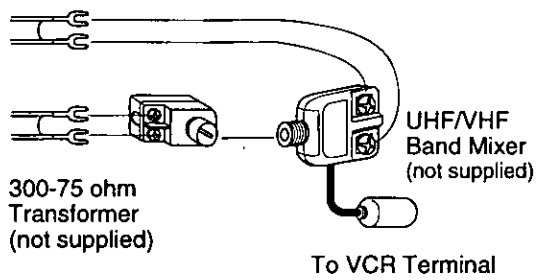

- If your TV has both post and plug-type VHF terminals, the post connection is recommended to minimize signal loss.

Between VCR and TV

Case 1: Screw & Plug Type Terminal

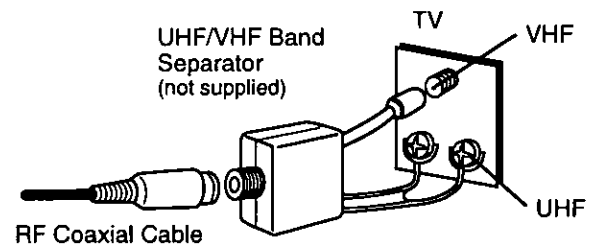

Case 2: Screw Type Terminal

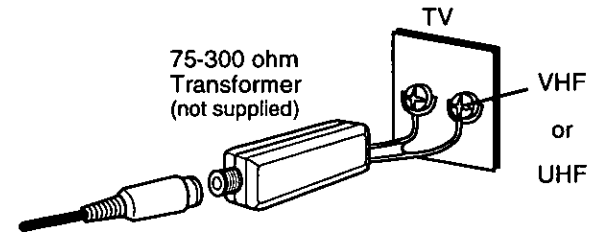

Case 3: Double Screw Type Terminal

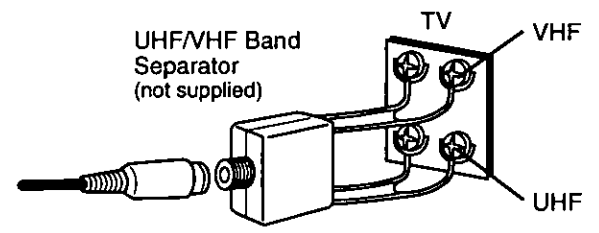

Case 4: Complex TV Terminal

TERMINALS ON BACK OF TV SET

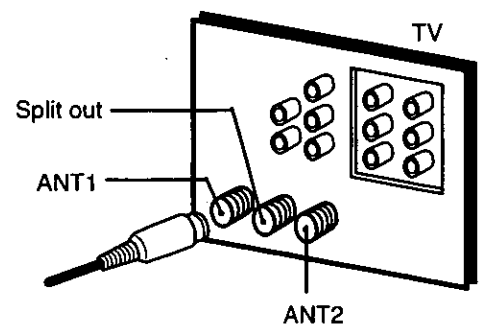

- Connect to one of the ANT terminals and select the same antenna number on the TV.



Other Connections

CABLE Connections

All connections on these pages are made with 75 Ohm coaxial cables.

Without a Converter/Descrambler Box

You can:

- 1) Use your VCR Remote Control to select channels.
- 2) Program one or more unscrambled channels for unattended recording.

You cannot:

- record or view scrambled channels with this connection.

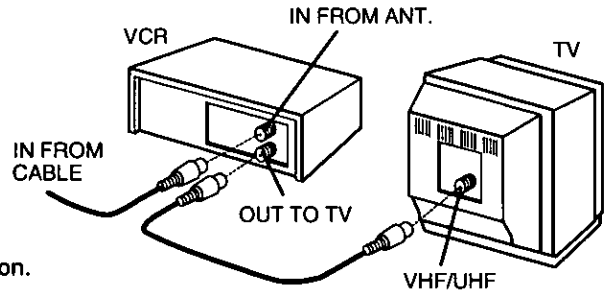

With a (CABLE to VCR) Converter/Descrambler Box

You can:

- 1) Record and view any channel including scrambled channels; channel selection must be made at the Cable TV Converter Box.
- 2) Program one channel for unattended recording.

You cannot:

- select channels from VCR or TV.
- watch one station while recording another.
- place channels in memory other than the Cable box output channel.

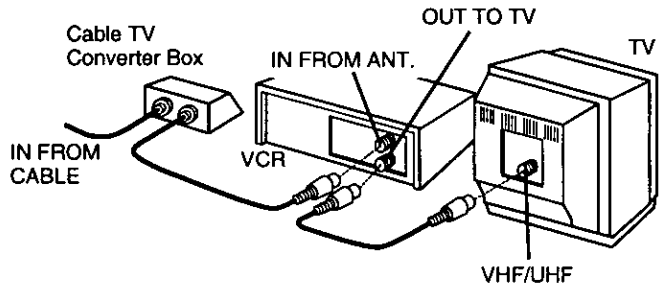

With a (VCR to TV) Converter/Descrambler Box

You can:

- 1) Use your VCR Remote Control to select channels.
- 2) Program unattended recordings of more than one unscrambled channel.

You cannot:

- record scrambled channels with this connection.

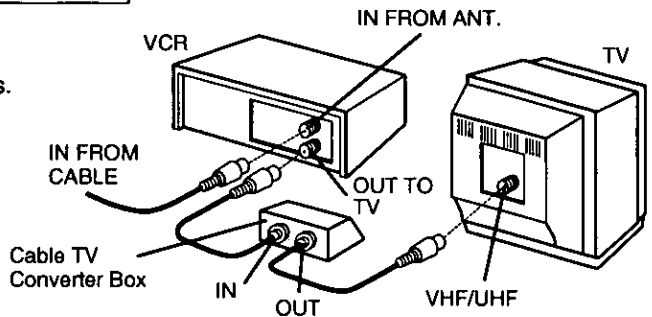

With Two Converter/Descrambler Boxes

If you want to record and view a combination of scrambled and unscrambled channels, you will need additional equipment. This connection requires two converter boxes, an A/B switch, and a 2-way splitter as shown here.

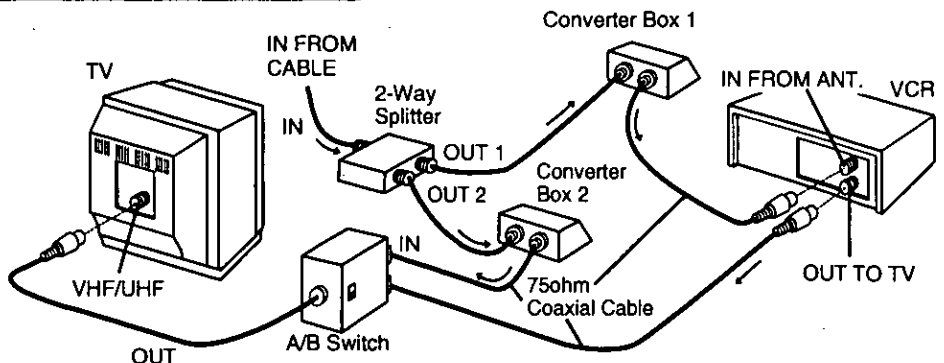

With a DSS Receiver

You can:

- 1) Record and view any channel including scrambled channels; channel selection must be made at the DSS Receiver.
- 2) Program one channel for unattended recording.

NOTE: The DSS receiver must be turned off to view programs from a cable box or antenna. See the DSS manual for details.

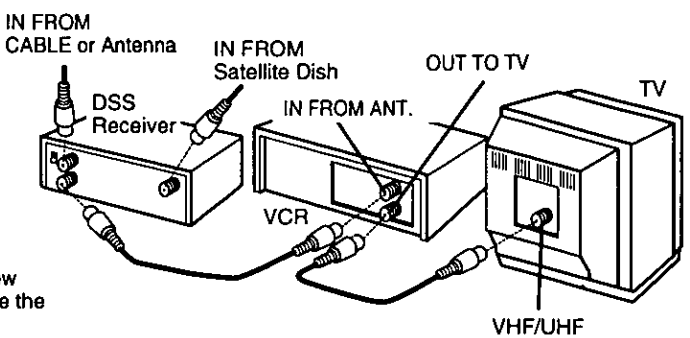

**DSS® is a registered trademark of DIRECTV, INC., a unit of GM Hughes Electronics.

Audio/Video Connections

If your TV has AUDIO IN and VIDEO IN terminals, you can connect your VCR to them to receive a higher quality picture and sound. If your TV is not stereo, you can connect a stereo amplifier to the VCR to enjoy stereo sound.

Audio/Video Connections

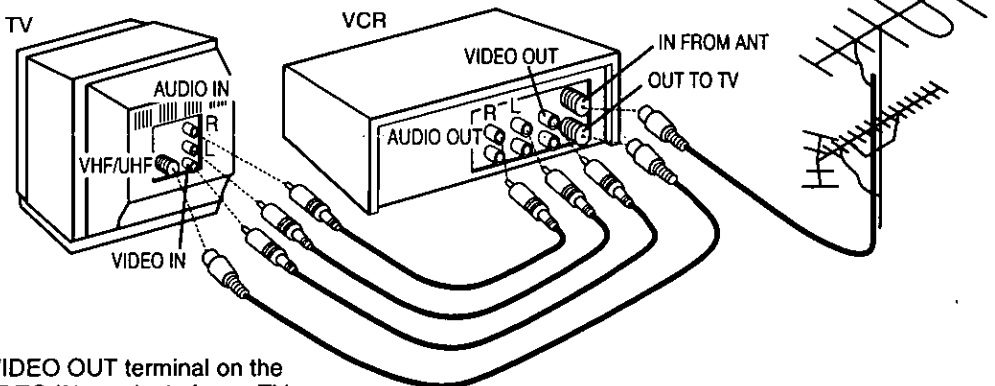

- 1 Connect the VIDEO OUT terminal on the VCR to the VIDEO IN terminal of your TV.
- 2 Connect the "L" and "R" AUDIO OUT terminals on the VCR to the "L" and "R" AUDIO IN terminals of your TV.
- 3 Set the VIDEO/TV selector of your TV (Monitor/Receiver) to "VIDEO."

NOTE: To use your TV as a VCR monitor, set the VIDEO/TV selector on the TV (Monitor/Receiver) to "VIDEO." Use the L Audio In jack for proper sound reproduction when connecting to a monaural TV.

Stereo Amplifier Connections

When you connect your VCR to a Stereo Component System, you can view the picture from the VCR while enjoying stereo from your audio system.

Connect the "L" and "R" AUDIO OUT terminals on the VCR to the "L" and "R" AUDIO IN terminals of your stereo.

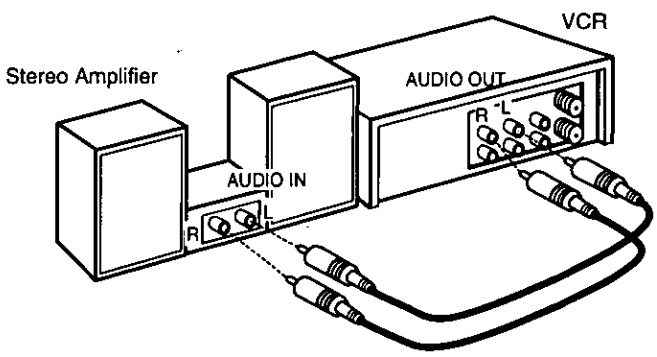

Note to CABLE system installer:
 This reminder is provided to call the CABLE system installer's attention to Article 820-40 of the NEC in USA (and to the Canadian Electrical Code in Canada) that provides guidelines for proper grounding and, in particular, specifies that the cable ground shall be connected to the grounding system of the building, as close to the point of cable entry as practical.

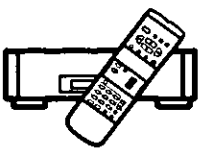

Location of Controls

Remote Control Buttons

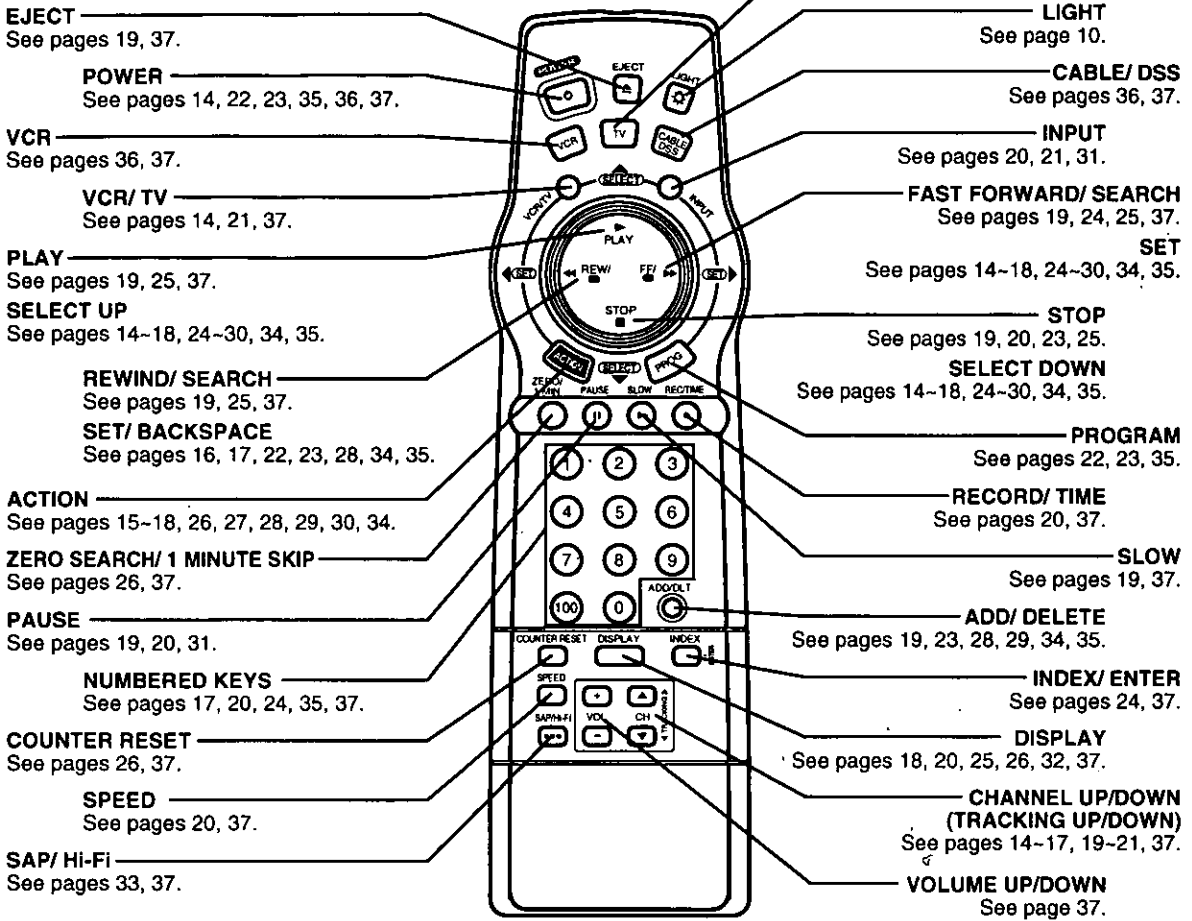

Light Tower Universal Remote Control

Light button: When the LIGHT button is pressed, the buttons which can be activated in the selected mode will light and the selected mode button (TV/VCR or CABLE DSS) will flash for 5 seconds. If no buttons are pressed within 5 seconds, the light will turn off in order to conserve battery power. Also, while holding down the buttons the selected mode button will flash so you will be able to see, in the dark, which mode has been selected.

EJECT button: When EJECT is pressed, the tape is ejected from Cassette Compartment. If EJECT is pressed during recording, the VCR will not respond to the command.

Front View of the VCR

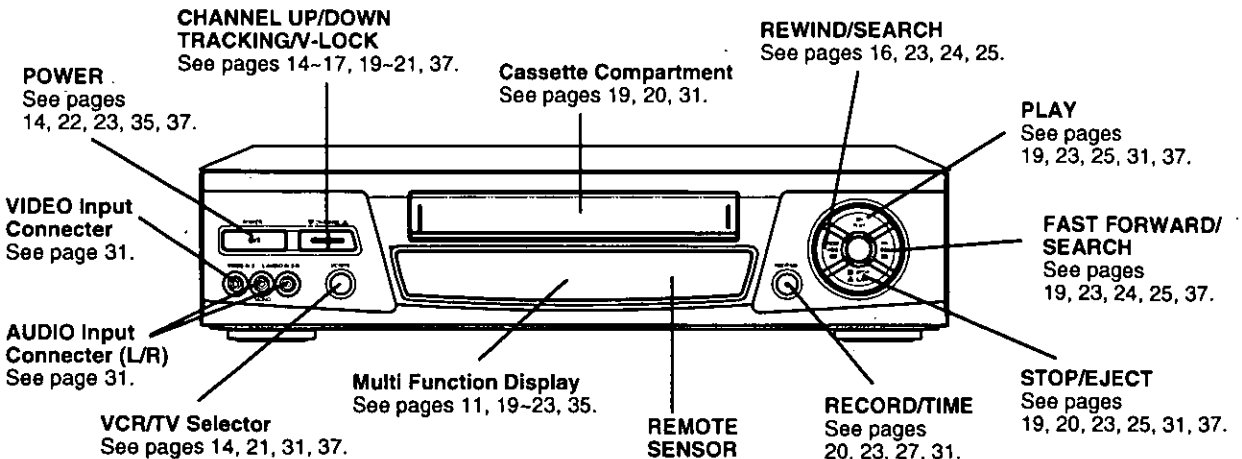

Multi Function Display

Cassette-In Indicator
Lights when a tape is in the VCR.

SPEED Display
Displays the recording speed.

Power Indicator
Lights when power is on.

Hi-Fi Indicator
Lights when Hi-Fi audio is monitored or played back.

Function Indicator
Shows what the VCR is doing.

- REC** and **▶** Record
- REC** and **||** Record-pause
- ▶** Playback
- ▶** Slow motion or Frame advance
- ||** Play-pause
- ◀** Flashing Rewind or Rewind search
- ▶** Flashing Fast forward or Forward search
- ||** Flashing Cassette ejecting

REC(ord) Indicator
Lights during recording.

Timer Indicator
Lights when the VCR is set for a Timer Recording, or when a length is set for a normal recording. The Timer Indicator flashes when a Timer Recording is set, but a tape has not been inserted into the VCR.

SAP Indicator
Lights when the station you are tuned to is broadcasting SAP.

STEREO Indicator
Lights when the station you are tuned to is broadcasting stereo.

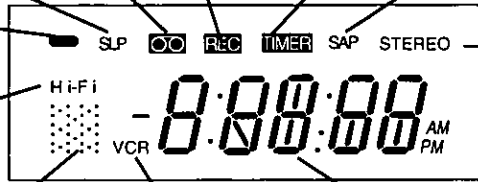

VCR Indicator
Lights when the VCR/TV selector is set to VCR.

Clock/Status/Channel Display
Displays the current time. Briefly displays VCR status when a function button is pressed. Briefly displays the channel number, or "L1" or "L2" when a channel or line input is selected. Displays the tape counter during tape operation.

Rear View of the VCR

AC Power Plug
While plugged into an AC outlet, the VCR consumes 3.7 W of electrical power in OFF condition.

Audio Output Connector (L/R)
See pages 9, 31, 32.

Video Output Connector
See pages 9, 31, 32.

VHF/UHF Antenna Input Terminal
See pages 6-9, 12, 32.

VHF/UHF Antenna Output Terminal
See pages 6-9, 12, 31, 32.

Audio Input Connector (L/R)
See pages 12, 31.

Video Input Connector
See pages 12, 31.

Channel 3/4 Switch
See pages 6, 14.

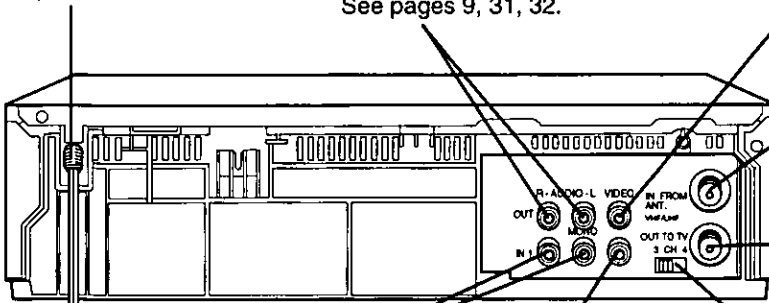



One Time VCR Setup

The setup on pages 14 through 16 is vital for proper VCR operation. Please read the instructions carefully and in the order presented.

NOTE: These first two pages contain reference material needed for setup on pages 14 -16. Please look over the information before you begin setup procedure.

Setup Overview

You will be performing the following tasks:

- Setting the language you want on-screen displays to appear in (English, Spanish, French).
- Telling the VCR what kind of equipment you are using to receive channels and how it is connected.
- Entering pertinent cable box or DSS receiver information if used.
- Entering a local PBS channel so that the VCR can receive auto clock set data. (Not available in all areas.)
- Placing channels in memory and setting the clock.

Please Note Which Connection Type You are Using.

Make sure all equipment is hooked up as described on pages 6-9. The diagrams below illustrate some of the basic connection types. Confirm which type you used for later reference.

Connection Type A

<CABLE BOX → VCR → TV>

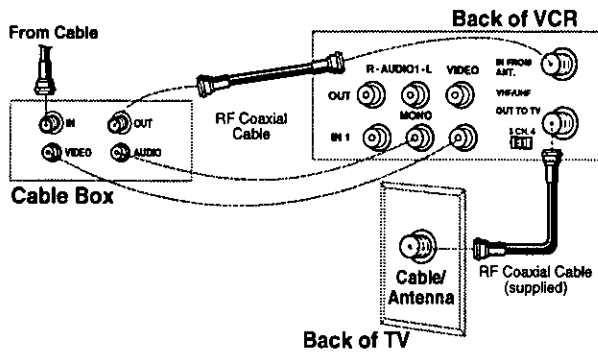

Or, <ANT/CABLE BOX → DSS BOX → VCR → TV>

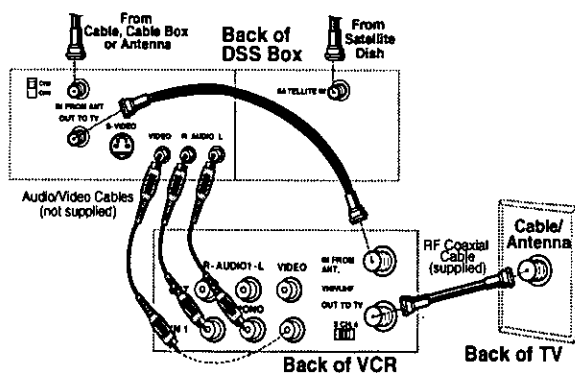

Connection Type B

<VCR → TV>

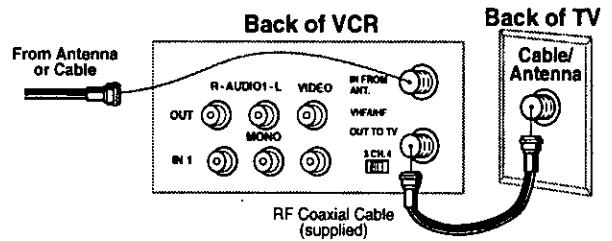

Or, <VCR → CABLE BOX → TV>

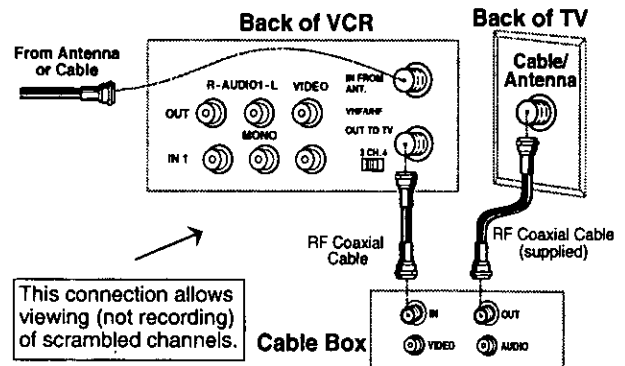

ONE TIME SETUP IMPORTANT NOTES:

- For detailed DSS receiver connection instruction, please see your DSS operating manual.
- The DSS receiver must be turned off to view programs from the cable box or antenna.
- If you use a DSS receiver, it must be turned off for auto clock set.
- If your cable box is not remote controllable, it must be tuned to your PBS channel.
- If you use Audio/Video Jack connection between the VCR and cable box or DSS receiver, you must also connect the RF coaxial cable in order to use the auto clock set and channel auto set features.

Cable Box/ DSS Receiver Code Number List

If your cable box or DSS receiver is remote controllable, refer to this list during setup on page 14.

Cable Box

Brand	Code Numbers
Archer.....	01, 05, 06, 44, 63
Cabletenna.....	01, 44, 63
Cableview.....	04, 30, 42, 44, 52, 63
Century.....	44, 51, 59, 75
Citizen.....	04, 30, 42, 44, 52, 63
Components.....	32, 39, 42, 44
Curtis.....	08, 09, 53, 61
Diamond.....	01, 44, 63
Eagle.....	13, 20, 22, 26, 40, 58, 62
Eastern.....	28
GC Brand.....	04, 30, 42, 44, 52, 63
Gemini.....	04
General Electric.....	01, 57
General Instruments	
.....	01, 02, 03, 04, 34, 55, 83, 65, 67, 68
Hamlin.....	14, 15, 28, 41, 102, 103, 104
Hitachi.....	31, 79
Jasco.....	04
Jerrold.....	01, 02, 03, 04, 34, 55, 83, 65, 67, 68
Macom.....	31
Magnavox.....	26
Matsushita.....	16, 17
Movietime.....	32, 39, 42, 44
NEC.....	32, 38, 40
Novavision.....	08, 09, 53, 61
NSC.....	32, 38, 40
Oak.....	11, 46, 101
Oak Sigma.....	11, 46, 101
Panasonic.....	16, 17
Philips.....	07, 13, 20, 23, 24, 50
Pioneer.....	05, 06
Pulsar.....	04, 30, 42, 44, 52, 63
Quest.....	05, 06
Radio SHACK, RECOTON.....	44, 51, 59, 75
RCA.....	16, 17
Realistic.....	44, 51, 59, 75

Brand	Code Numbers
Regal.....	14, 15, 28, 41, 102, 103, 104
Regency.....	28
Rembrandt.....	01, 29, 32, 39, 42, 44, 63
Samsung.....	05, 06, 32, 40, 42
Scientific Atlantic.....	08, 09, 61, 53
Sheritech.....	27
Signal.....	26
SL Marx.....	06, 32, 40, 42, 43, 44, 52, 63
Spucer.....	16, 17
Standard.....	32, 39, 42, 44
Stargate.....	04, 06, 30, 32, 40, 42, 44, 52, 63
Sylvania.....	19
Telecaption.....	77
Teknika.....	74
Televue.....	06, 32, 40, 42
Texscan.....	18, 19
Tocom.....	01, 33, 34, 42, 66
Toshiba.....	36
Unika.....	01, 44, 63
Universal.....	42, 43, 44, 52, 63
Viewstar.....	13, 20, 22, 26, 40, 58, 62
Vid Tech.....	64
Vidtek.....	36, 64
Videoway.....	07, 23, 50
Zenith.....	07, 23, 50

DSS (Digital Satellite System Receiver)

Hitachi.....	93
Hughes.....	93
Magnavox 1/ Uniden 1.....	94
Magnavox 2/ Uniden 2.....	95
Panasonic.....	96
RCA.....	97
Sony.....	98, 105
Toshiba.....	92

Note: During setup you will be instructed to enter your brand code number. As some brands have multiple codes, it may be necessary to try different codes to attain the proper results. These codes are for Cable box or DSS Box setup for Auto Clock and VCR Plus+ recording only. For TV/Cable Box Multi-Brand Control operation, please see page 36.

Positioning Your Cable Box or DSS Receiver

If your cable box or DSS receiver is remote controllable, place it on or near the VCR as shown in the example below. The VCR transmits an infrared signal from two locations. Be sure not to cover the transmitter windows.

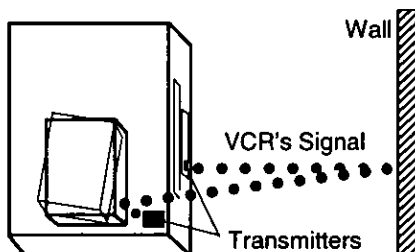



One Time VCR Setup

***Important:** If the remote control POWER, ACTION, PROG, CH▲▼, INDEX or ADD/HLT button does not work when pressed, press the VCR button on the remote and try the button again.

When the VCR is turned on for the first time, it automatically enters the setup mode.

Setup includes the following:

- Choose the language for on-screen menus and messages.
- Tell the VCR how your equipment is hooked up (pages 6-9) so the VCR can correctly place channels into memory.
- Get the VCR ready for clock set.

To Set the Language, Cable/DSS Receiver, Channels and Auto Clock

1 Turn the TV and VCR on.*

2 Tune your TV to the VCR output channel (the same one you set on the back of the VCR: CH3 or CH4).

- If you used audio/video jack connection, tune the TV to its video input.

3 Press CH ▲ for English on-screen displays.

Or, press CH ▼ for Spanish on-screen displays.

Or, press VCR/TV for French on-screen displays.

- You can also set the language using the buttons on the VCR.
- If the wrong language is set, see the "Reset all VCR Memory Functions" section on page 5.
- The VCR should be connected to an antenna or cable box (page 6-9).

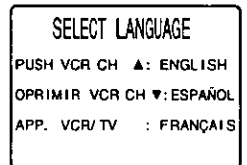

4 Press ▲▼ to select your hookup, and then press ► to set.

- If you selected "CABLE/DSS BOX ►VCR ►TV," continue with step 5. If not, go to "Alternate Instructions on page 16."
- If you are using the CABLE/DSS BOX ►VCR ►TV connection method, only the cable box output channel will be placed in memory.

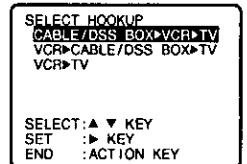

5 Press ▲▼ to select your cable box or DSS receiver output channel number, and then press ► to enter.

- If necessary, refer to your cable box manual.
- If both a cable box and DSS receiver are used, set the output channel of the DSS receiver.
- If you are using Audio/Video jack connections to your cable box, select and set "VIDEO OUT" as the output channel.

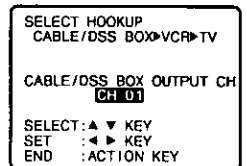

6 Press ▲▼ to select your cable box or DSS receiver code number, and then press ► to enter. (Refer to the list on page 13.)

- If your cable box or DSS receiver doesn't have a remote control, select "NO REMOTE." Then, go to Alternate Instructions on page 16.
- This determines whether the VCR will control your cable box or DSS receiver.

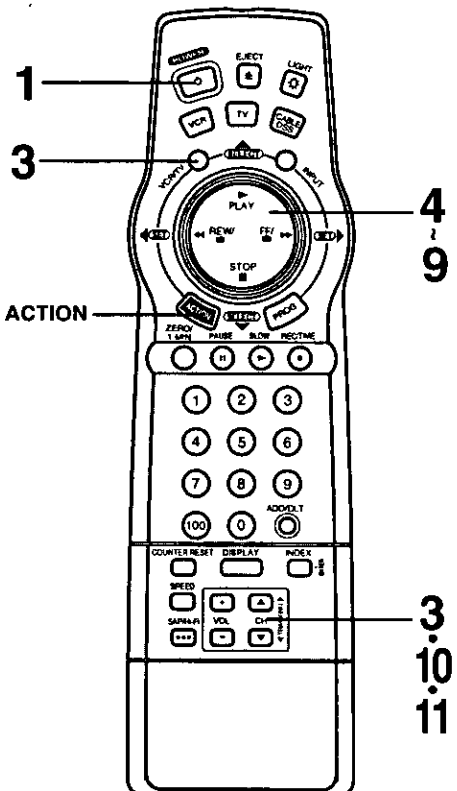
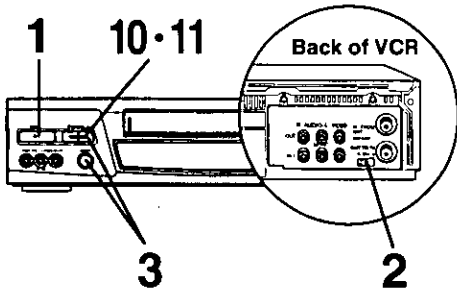
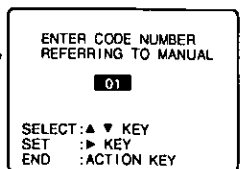

Using ▲▼◀▶ keys

When a menu screen is displayed, the PLAY, STOP, REWIND, and FF buttons on the remote control function as ▲▼◀▶ only. Use the buttons on the VCR for play, stop, rewind, and fast forward functions. When a program screen is displayed, the REC, FF, REW, and PLAY buttons on the remote control and the VCR function as ▲▼◀▶ only. (See Timer Recording Using VCR Buttons on page 23.)



If you use a cable box, tune it to channel 02.
If you use a DSS receiver, tune it to channel 270.

- 7** Press **▶** to continue.
- "NOW TRANSMITTING" appears.

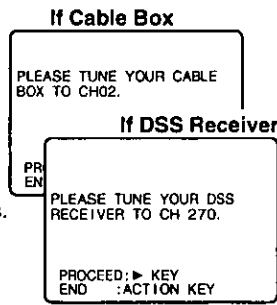

- 8** Press **▲▼** to select "YES" or "NO," and then press **▶** to enter.

If you use a cable box and selected "YES," go to step 9.

If you use a DSS receiver and selected "YES," go to "Alternate Instructions" on page 16.

If you selected "NO," the screen in step 6 on page 14 will reappear.

Try entering a different code assigned to your brand and/ or repositioning the equipment (see page 13).

If the answer is still "NO," cable box or DSS receiver control is not available.

For channel and clock auto set, press ACTION to display the "SET UP CHANNEL" screen. Then, press **▲▼** to select "AUTO SET." Now, press **▶** and **CH ▲** to start the auto set.

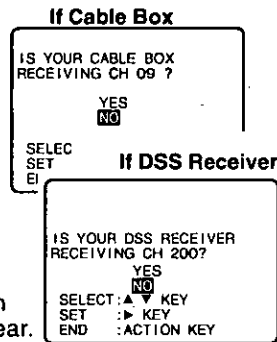

If the Auto Clock Set displayed time is incorrect...

If you use a cable box and receive more than one PBS station, try auto clock set again.

Follow the "To Set or Reset the Clock" section on page 17 and when the instructions call for you to enter a PBS station, enter the one you have not tried yet.

If "AUTO CLOCK SET IS INCOMPLETE" appears...

The screen below will appear on-screen if auto clock set data is not available in your area.

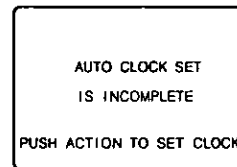

Press ACTION to display the "SET CLOCK" (manual) screen, and then do steps B and C on page 16.

Confirm that your cable box is on and that your DSS receiver is off.

- 9** Press **▲▼** to select your local PBS channel number you receive on your cable box, and then press **▶** to display the "CLOCK AUTO SET" screen.

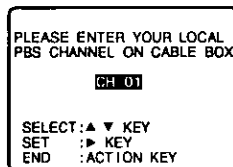

- 10** Press **CH ▲** to start Auto Clock Set.

- If you live near a different time zone, be sure to enter the PBS channel in your time zone.
- "AUTO CLOCK SET PROCEEDING" appears.

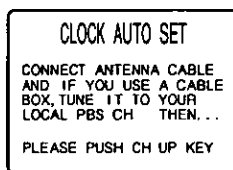

- 11** This display appears when auto clock set is completed.

Confirm that the time is correct and press **CH ▲** to exit.

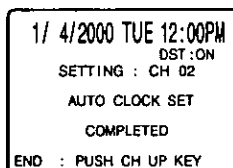

Note:

If you use a cable box and receive more than one PBS station, you may exit the manual clock set screen and try auto clock set again.

Follow the "To Set or Reset the Clock" section on page 17 and when the instructions call for you to enter a PBS station, enter the one you have not tried yet.



- Auto clock set will be performed when the VCR is turned off the first time each day. If you use a cable box and you want auto clock set to be performed, the cable box must be left on and tuned to the PBS channel before the VCR power is turned off.

One Time VCR Setup

***Important:** If the remote control POWER, ACTION, PROG, CH▲▼, INDEX or ADD/DELETE button does not work when pressed, press the VCR button on the remote and try the button again.

Alternate Instructions

Complete the following steps if, any of the following applies:

- You selected connection type 2 (VCR▶CABLE/ DSS BOX▶TV or VCR▶TV) in step 4 on page 14.
- You selected "NO REMOTE" in step 6 on page 14 (your cable box or DSS receiver is not remote controllable).
- You use a DSS receiver and selected "YES" in step 8 on page 15.

1 Turn on the cable box and set it to the local PBS channel.

- If you live near a different time zone, make sure to set the channel in your time zone.
- If you use a DSS receiver, it must be turned off.

CHANNEL/CLOCK AUTO SET

CONNECT ANTENNA CABLE AND IF YOU USE A CABLE BOX, TUNE IT TO YOUR LOCAL PBS CH THEN... PLEASE PUSH CH UP KEY

2 Press CH ▲* to start Channel Auto Set and Auto Clock Set.

- The following messages appear. "CH AUTO SET PROCEEDING" "AUTO CLOCK SET PROCEEDING"

This screen appears to confirm that auto clock set is completed.

3 Confirm that the time is correct and press CH ▲ to exit.

If this screen appears, auto clock set is not available in your area. Please set the clock manually as described below.

```

1/ 4/2000 TUE 12:00PM
DST:ON
SETTING : CH 02
AUTO CLOCK SET
COMPLETED
END : PUSH CH UP KEY
    
```

```

AUTO CLOCK SET
IS INCOMPLETE
PUSH ACTION TO SET CLOCK
    
```

A Press ACTION to display the SET CLOCK screen.

B Press ▲▼ and ◀▶ to select and set the month, date, year, time, and DST. (Daylight Saving Time).

To Make Corrections, repeatedly press ◀▶ to move the cursor to the incorrect entry and make the correction.

C Press ACTION twice to start the clock and exit this mode.

```

--- SET CLOCK ---
1/ 4/2000 TUE 12:00PM
DST:ON
SELECT MONTH
SELECT:▲▼KEY
SET :▶KEY
END :ACTION KEY
    
```

```

--- SET CLOCK ---
1/ 4/2000 TUE 12:00PM
DST:ON
SET COMPLETED
SET :◀▶KEY
START :ACTION KEY
    
```

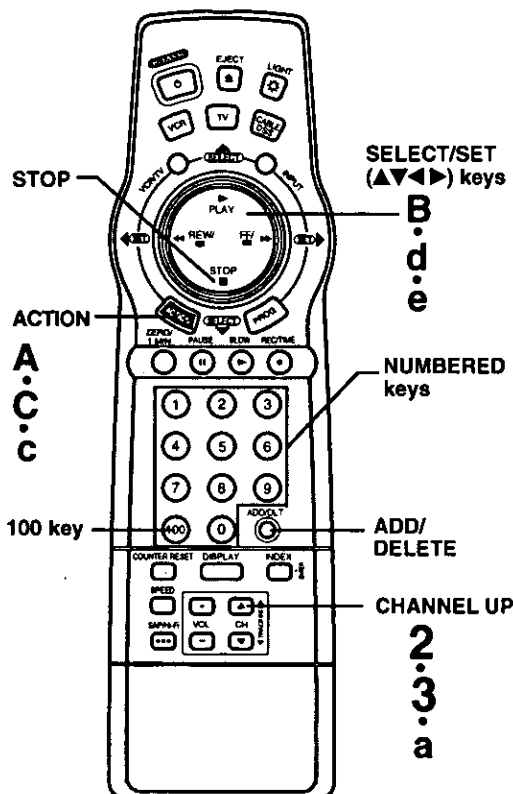

If the displayed time and DST are not correct...

If you happen to live close to two time zones, the VCR may have recognized the PBS channel (setting channel) in the wrong time zone. Please do the following to correct the situation.

- Make a note of the SETTING:CH number shown on screen and press CH ▲ to exit.
- Delete the setting channel from the VCR channel memory. (See the "To Add or Delete a Channel" section on page 17.)
- Press ACTION to display the menu.
- Press ▲▼ to select "SET CLOCK," and then press ▶ to display the "SET CLOCK" screen.
- Press ▲▼ and ▶ to select and set "AUTO CLOCK SET."
- Follow the One Time VCR Setup instructions on pages 14~16.
 - If you use a cable box and have multiple PBS stations, tune the cable box to a different PBS station and try auto clock set using the menu.

To Change On-Screen Display Language

- Press ACTION to display the menu.
- Press ▲▼ to select the language.
English: LANGUAGE
Spanish: IDIOMA
French: LANGUE
- Press ► repeatedly to change the language.
- Press ACTION to exit this mode.

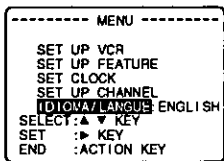

To Add or Delete a Channel

- Select a channel using the NUMBERED keys to add or CH ▲/▼ to delete.
- Press ADD/DLT to add or delete the channel.
 - To select a channel once it's deleted, use the NUMBERED keys on the remote control.

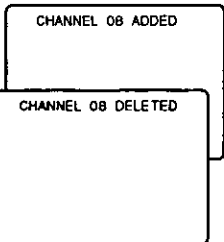

To Set or Reset the Clock

In case the clock is wrong, or a power failure occurred.

- Press ACTION to display the menu.
- Press ▲▼ to select "SET CLOCK," and then press ► to display the "SET CLOCK" screen.
- Press ▲▼ to select "MANUAL," and then press ► to display the SET CLOCK screen.
- Press ▲▼ and ◀▶ to select and set the date, time and DST. (Daylight Saving Time).
- Press ACTION twice to start the clock and exit this mode.

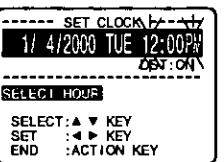
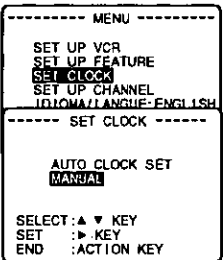

To Replace Channels in Memory

In case you have cable installed, etc. .

- Press ACTION to display the menu.
- Press ▲▼ to select "SET UP CHANNEL," and then press ► to display the "SET UP CHANNEL" screen.
- Press ▲▼ to select "ANTENNA," and then press ► to set your antenna system (TV or CABLE).
- Press ▲▼ to select "AUTO SET," and then press ► to display the "CHANNEL/CLOCK AUTO SET" screen.
- Follow the One Time VCR Setup instructions on page 14~16.
 - Clock Auto Set will be performed when channels are replaced in memory. To cancel, press STOP when "AUTO CLOCK SET PROCEEDING" appears on-screen.

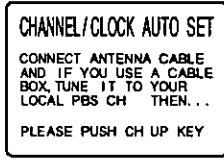
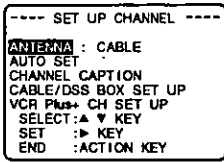
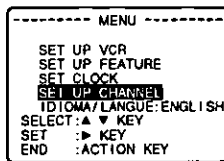

To Setup the VCR in Case a Cable Box or DSS Receiver was Installed or Replaced

- Press ACTION to display the menu.
- Press ▲▼ to select "SET UP CHANNEL," and then press ► to display the "SET UP CHANNEL" screen.
- Press ▲▼ to select "CABLE/DSS BOX SET UP," and then press ► to display the "SELECT HOOKUP" screen.
 - To exit this mode, press ACTION three times.
- Press ▲▼ and ► to select and set "CABLE/DSS BOX ► VCR ► TV," and then continue with steps 5~8 on pages 14, 15.

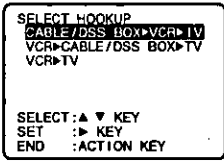
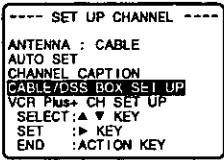
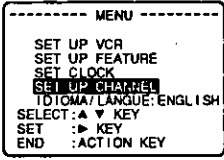

If these steps are completed, the "SET UP CHANNEL" screen will appear.

When Using the 100 key

When selecting CABLE channels 100 to 125 with the NUMBERED keys, first press the 100 key and then enter the remaining two digits. For example, to select channel 125: Press NUMBERED keys 100, then 2, then 5.



- This VCR will accurately maintain its calendar up to Dec. 31, 2096, 11:59PM.
- Normal TV or Cable channels are automatically selected and placed in memory depending on how your VCR is hooked up.
- If you change your Cable Box or DSS Receiver, please perform the "To Set or Auto Clock Set" section above.



On-Screen Displays (OSD)

***Important:** If the remote control POWER, ACTION, PROG, CH▲▼, INDEX or ADD/HLT button does not work when pressed, press the VCR button on the remote and try the button again.

Function & Channel Display

When a function button is pressed, e.g. PLAY, or you change channels, a 4 second display appears first in large and then small characters. (Some Station names may also appear if Channel Caption is set. See pages 28, 29.)

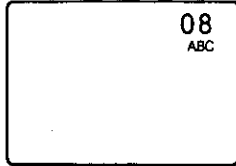

Menu Screen

- 1 Press ACTION* to display the menu.
- 2 Press ▲▼ and ► to make your selection.

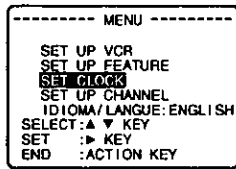

- To get the most from each feature, please read the Operating Manual before attempting any operation.

VCR Status & Clock Display

Press DISPLAY to display or remove the overlay shown below.

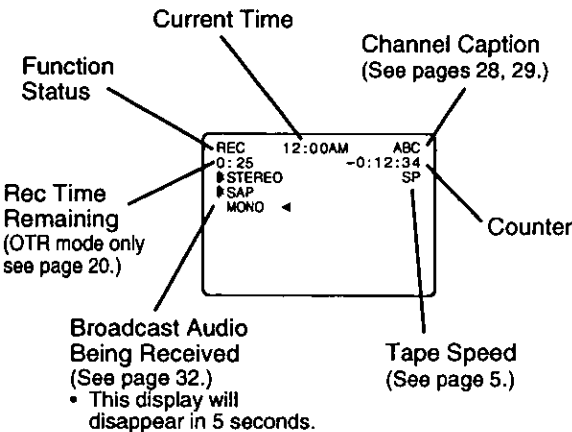

Blank Tape/ No Video Signal Indication

Whenever a blank section of a tape comes up in Play mode, or when the selected channel has no broadcast signal with the Blue Back ON/OFF Feature (page 30) set to ON, the TV screen will turn solid blue.

Warning and Instruction Displays

These displays will alert you of a missed operation or provide further instructions.

If no active channels are found for CHANNEL MEMORY... (See page 16.)

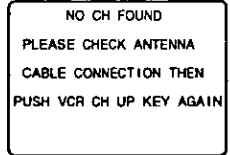

If you attempt to set or review a Timer Recording and the Clock is not set... (See page 22.)

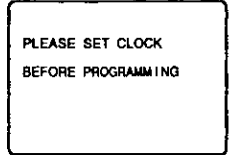

After a Timer Program has been set... (See page 22.)

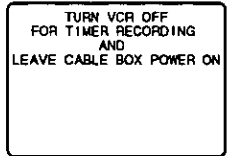

If you press REC on the remote control or VCR, and a cassette is inserted with no record tab... (See page 20.)

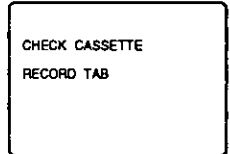

If you press PLAY, FF, REW, or REC on the remote control or VCR without a cassette inserted... (See pages 19, 20.)

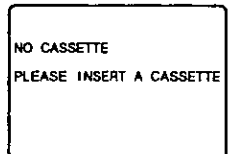

If you press POWER or STOP during a Timer Recording... (visible in VCR mode only) (See page 23.)

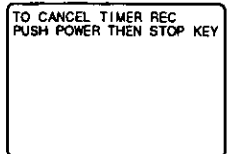

If head cleaning becomes necessary while playing back a tape... (See page 5.)

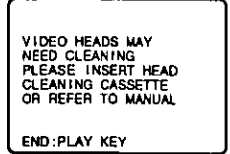

If you press a function button other than STOP/EJECT or POWER on the VCR, or STOP or EJECT or POWER on the remote control while the VCR is in VCR Lock mode... (See page 27.)

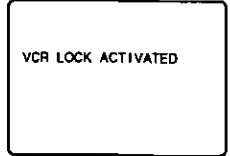

If you press POWER, ACTION or PROG on the remote while in TV or CABLE/DSS mode... (See pages 36, 37.)

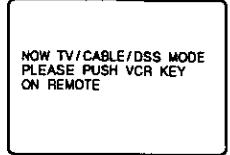



Playback a Tape

✓ Check list before you begin.

- All connections are made. (See pages 6-9.)
- TV and VCR are plugged in.
- TV is turned on and set to the VCR channel (CH 3 or 4).

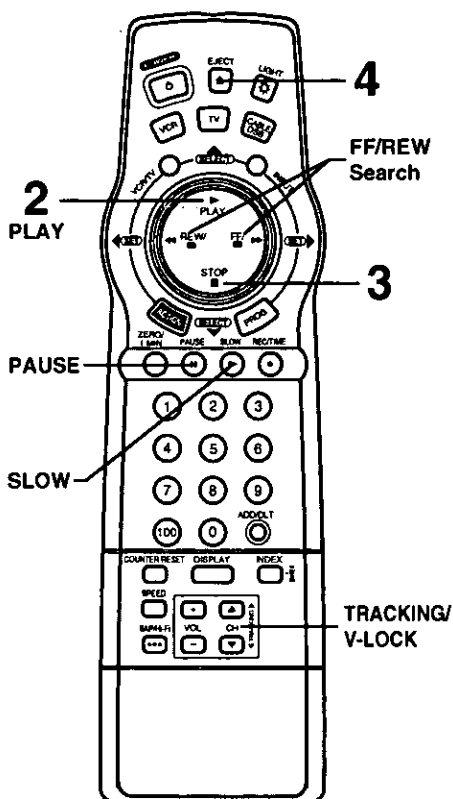
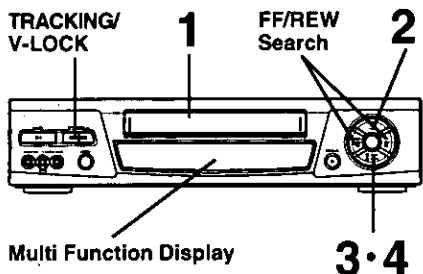

Caution:

Please inspect your cassette tapes and remove any loose or peeling labels to prevent them from becoming jammed in your unit.

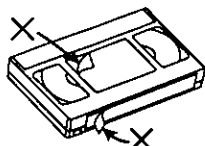

1 Insert a cassette.

- VCR power comes on automatically.
- "VCR" lights in the Multi Function Display.

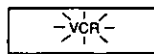

2 Press PLAY on the remote or VCR to start playback.

- Playback begins automatically if cassette has no record tab.

3 Press STOP on the remote or VCR to stop playback.

- To rewind the tape, press REW.

4 Press EJECT on the remote or VCR to eject the cassette.

- You may eject a cassette with power on or off.

To Find a Particular Scene During Playback

Press REW or FF during playback to search for a scene.

- Search speed for SP mode tapes is 7 times and SLP mode tapes is 21 times the normal speed.
- Some noise bars will appear during search.

Special Effects During Playback

These features work best in SP or SLP mode. The sound will be muted.

Slow Motion Playback

Press SLOW to start slow motion playback during playback. Press PLAY or SLOW to release.

Still (Freeze) Frame Picture

Press PAUSE to freeze and release the picture.

- To reduce picture noise, first press SLOW. Then, use CH (TRACKING) ▲/▼ to clear up the picture. Now, press PAUSE.

Frame by Frame Advance

In Still mode, hold down SLOW to advance the still picture one frame at a time. Press PAUSE to release.

Features for a Quality Picture

Digital Auto Picture

This feature automatically controls the video output signal for less noise depending on the tape condition.

Digital Auto Tracking

This feature continuously analyzes the signal and adjusts for optimum picture quality.

Manual Tracking Control (to reduce picture noise)

Use during Playback and Slow Motion mode to reduce picture noise. Press CH (TRACKING) ▲/▼ during playback until the picture clears up. To return to Auto Tracking mode, press POWER off and then on again.

V-Lock Control (to reduce picture jitter)

In Still mode, CH (TRACKING) ▲/▼ operate as a V-Lock control. Press ▲/▼ until the picture is stabilized.



- After the VCR is in Still or Slow mode for 3 minutes, it will switch to the Stop mode automatically to protect the tape and the video head.

Record On a Tape

***Important:** If the remote control POWER, ACTION, PROG, CH▲▼, INDEX or ADD/HLT button does not work when pressed, press the VCR button on the remote and try the button again.

Check list before you begin.

- All connections are made.
(See pages 6-9.)
- VCR is plugged in.
- TV is turned on and set to the VCR channel (CH 3 or 4).

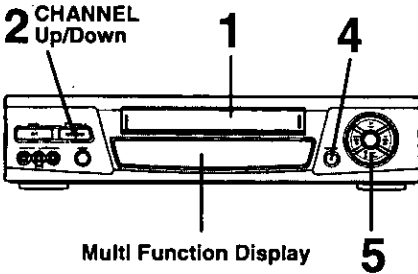

1 Insert a cassette with record tab.

- VCR power comes on automatically.

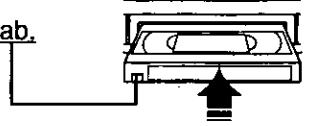

2 Press CH ▲/▼* or NUMBERED keys to select a channel.

- Or, press CHANNEL ▲/▼ on the VCR.
- Holding down CH ▲/▼ will increase the channel search speed.
- To record from an outside source, press CH ▲/▼ or INPUT to select "LINE1" or "LINE2" (see page 21).



3 Press SPEED to change the recording speed.

- SP = Standard Play ,
- LP = Long Play
- SLP = Super Long Play
- (See page 5.)

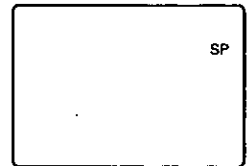

4 Press REC/TIME on the remote control or VCR to start recording.

- To edit out unwanted portions, press PAUSE to pause the recording in progress. To release, press PAUSE again.
- (After the VCR has been in Pause mode for 5 minutes, it will stop automatically to protect the tape and video head.)

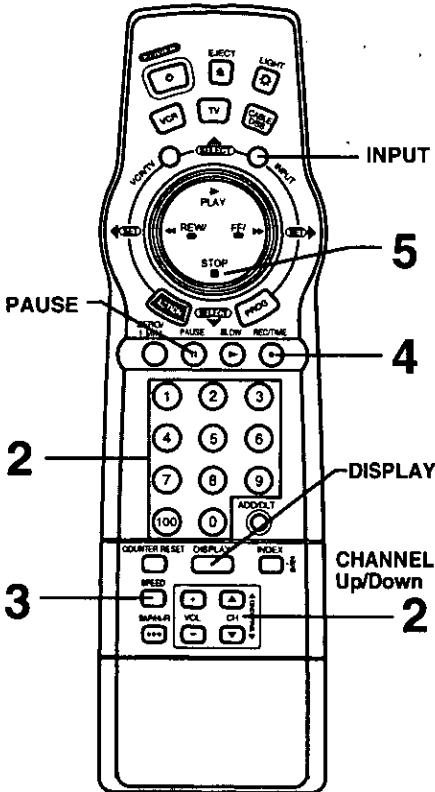

One Touch Timer Recording (OTR)

The VCR starts recording and turns itself off at a preset time. In step 4, **press REC/TIME** repeatedly to set the length of the recording. Each press will change the stop time as shown.

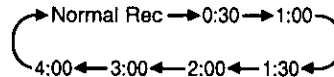

- "TIMER" lights in the Multi Function Display.
- The remaining recording time can be displayed by pressing DISPLAY in OTR mode.

5 Press STOP to stop recording.

- Or, press STOP/EJECT on the VCR.

Selecting the Input Mode

Press INPUT.

The display will change in the order below.

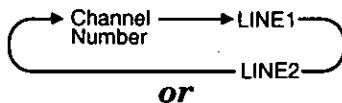

Press CH ▲▼.

The display will change in the order below.

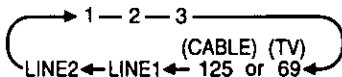

- LINE1: For rear audio/video connection.
- LINE2: For front audio/video connection.
- When LINE is selected, "L1" or "L2" is displayed in the Multi Function Display for about 4 seconds.

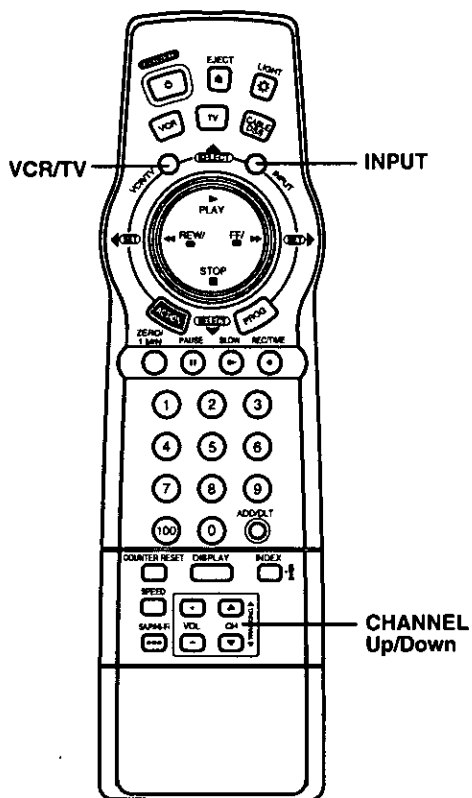
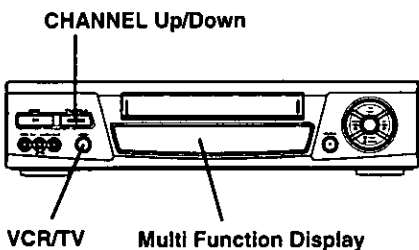

Record One Program While Watching Another

- 1 Press VCR/TV while recording is in progress to turn off the VCR indicator in the Multi Function Display.
- 2 Use the TV channel controls to select a program. The VCR will continue to record your program while you watch any channel you choose.
 - To switch back and forth between the recording and viewing channel, press VCR/TV.

Selecting Channels at the VCR

- 1 Turn your TV and VCR on.
 - VCR Indicator lights on the Multi Function Display. If indicator doesn't light, press VCR/TV to turn it on.
- 2 Use CH ▲▼ on the remote control or VCR to select channels.
 - To switch back to TV channel selection, press VCR/TV to turn VCR indicator off, or simply turn the VCR power off.



Timer Recording

***Important:** If the remote control POWER, ACTION, PROG, CH▲/▼, INDEX or ADD/HLT button does not work when pressed, press the VCR button on the remote and try the button again.

You can set up the VCR to record a one time, daily, or weekly program while you are away or otherwise occupied. Up to 8 programs can be stored in memory.

Check list before you begin.

- All connections are made. (See pages 6-9.)
- TV and VCR are plugged in and turned on.
- VCR/TV selector is set to "VCR."
- Clock is set to correct time.
- Record tab in place. (See page 5.)



7 Multi Function Display

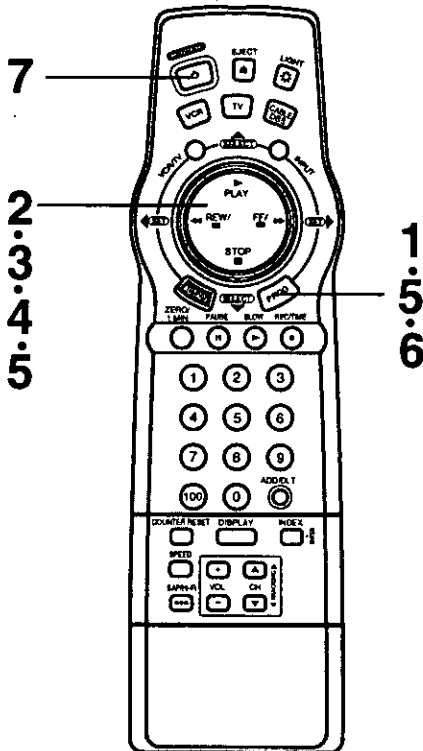

1 Press **PROG*** to display the "SET PROGRAM" screen.



2 Press **▲▼** to select "TIMER PROGRAM," and then press **▶** to display the program screen.

- If a program is already in memory, press **▲▼** and **▶** to select an unused program number.

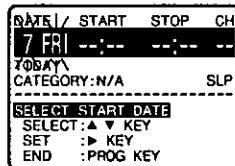

3 Press **▲▼** and **▶** to select and set one of the following:

- 1-31 =One time recording
- DAILY =Same time MON-FRI
- WEEKLY (SUN-SAT) =Same time once a week

Example

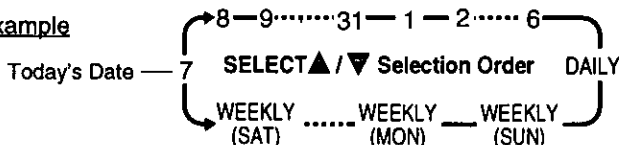

4 Press **▲▼** and **◀▶** to select and set each of the remaining items at right.

- Remaining Items to be set:**
- START time
 - STOP time
 - CH(annel) number, or LINE for outside source recording
 - Category (N/A [not applicable], SPORTS, MOVIE, COMEDY, MUSIC, DRAMA)
 - Speed (SP, LP, SLP)

To Make Corrections

Repeatedly press **▶** to move the cursor to the right, or **◀** to move to the left to the incorrect entry and make the correction.

5 Press **PROG** to end the program.

- This screen appears for confirmation.

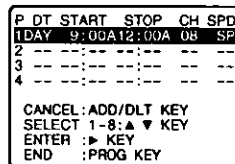

If you use a DSS receiver and enter a channel number of 100-125, the screen at right appears.

Press **▲▼** to select "DSS" or "CABLE," and then press **▶** to enter.

- The confirmation screen appears above right after this selection.

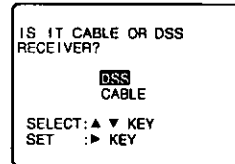

To Enter More Programs

Press **▲▼** and **▶** to select and set a blank program number, and then repeat steps 3 and 4.

6 Press **PROG** to exit this mode.

7 Press **POWER** off to set the timer.

- When recording programs via a cable box, make sure the cable box is left ON and tuned to the desired channel.



Multi Function Display

Important notes when using a DSS receiver

- When recording programs via a DSS receiver, the DSS receiver must be left on.
- When recording programs via an antenna or cable, the DSS receiver must be turned off.



- A cassette with no record tab is ejected and "TIMER" flashes when the power is turned off to set the timer.
- If the start times of two programs overlap, the lower numbered program will have priority.
- If the start time for a timer recording comes up during a normal recording or One Touch Recording (page 20), the timer recording will not be performed.
- If there is a power interruption of more than one minute, the recording will not be performed or continue.

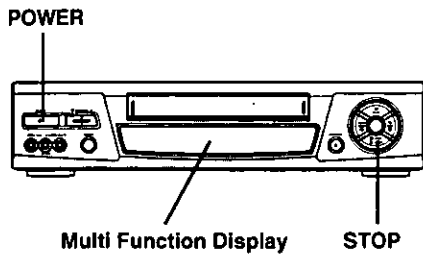

Cancel a Timer Recording: (Recording is in progress)

Press POWER and then STOP within 10 seconds to cancel the timer recording.

- The TIMER indicator goes out in the Multi Function Display.

Replace Program Contents: (Recording is not in progress)

- 1 Press PROG to display the "SET PROGRAM" screen.
- 2 Press ▲▼ to select "TIMER PROGRAM," and then press ► to display all currently set programs.
- 3 Press ▲▼ and ► to select and set a program number.
(See page 22.)
- 4 Press ▲▼ and ◀▶ to select and set replacement timer information.
- 5 Press PROG twice to exit this mode.

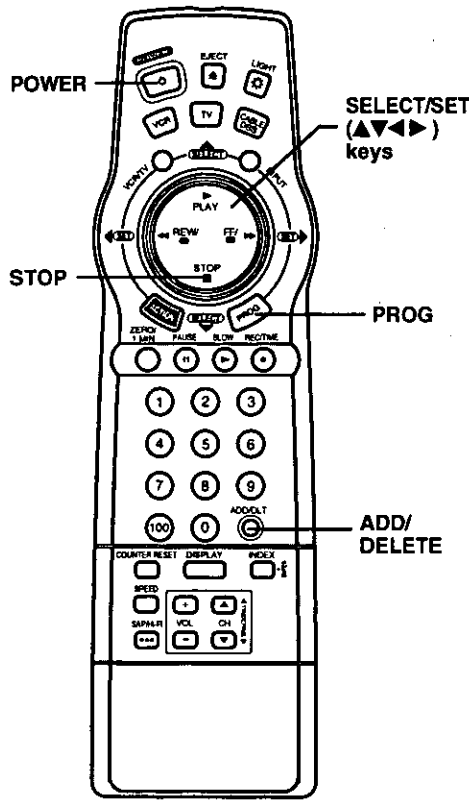
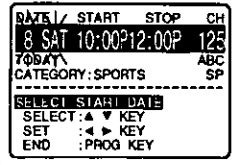
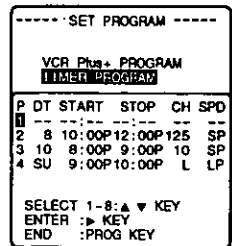

Review or Clear Program Contents: (Recording is not in progress)

- 1 Press PROG to display the "SET PROGRAM" screen.
- 2 Press ▲▼ to select "TIMER PROGRAM," and then press ► to display all currently set programs.
- 3 Press ▲▼ to select a program number.
- 4 Press ADD/DLT if you want to clear the program.
- 5 Press PROG to exit this mode.

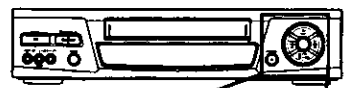
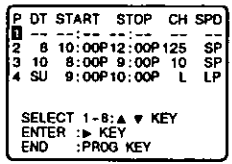
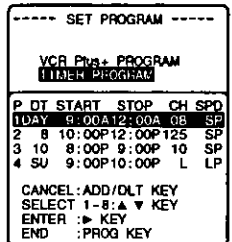

Timer Recording Using VCR Buttons

(Make sure a cassette tape is not inserted in the VCR.)

- 1 Hold down STOP/EJECT and press REW to enter the Program mode.
- 2 Press FF or REC/TIME repeatedly or hold down to make selections.
- 3 Press PLAY to set the item and move on.
 - To make corrections, repeatedly press PLAY to move the cursor to the right, or REW to move to the left to the incorrect entry and make the correction.
- 4 Press STOP/EJECT and REW together to display program contents after all items have been entered.
 - You cannot clear programs with the VCR buttons.
- 5 Hold down STOP/EJECT and press REW, (release REW first, and then release STOP/EJECT) to exit this mode.
- 6 Insert a cassette with record tab and press POWER off to set the timer.

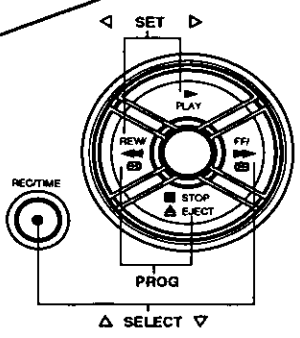



Tape Operation

***Important:** If the remote control POWER, ACTION, PROG, CH▲▼, INDEX/M/A SKIP or ADD/HLT button does not work when pressed, press the VCR button on the remote and try the button again.

VHS Index Search System

Each time you start a recording, an invisible index mark is placed on the tape. When timer recordings are made, program index and program information (see "Time Stamp Feature" on page 30) are also included. You can then use these index marks to access or scan your recordings.

Direct Access

(For normal and/or timer recordings)

This feature allows you to go directly to the recording you want from anywhere on the tape by entering the appropriate index number.

1 Press **INDEX*** to display the "SELECT SEARCH MODE" screen.

- This screen appears only if there are timer recordings on the Program Index list. If this screen does not appear, go to step 3.

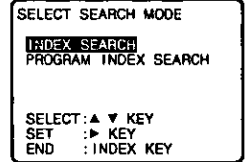

2 Press **▲▼** to select "INDEX SEARCH," and then press **►** to display the "INDEX" screen.

3 Press a **NUMBERED** key to select the desired recording.

- To calculate the number, see below.

4 Press **REW** or **FF** to start a reverse or forward search.

- When the designated location is reached, the VCR goes into Playback mode.

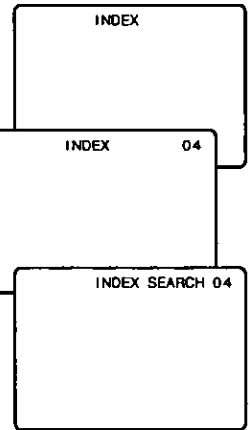

To calculate the Index Number

Count forward or backward each recording starting point, including the recording you want to see, from wherever you are on the tape.

Example 1:

If you are watching recording 4 and you want to watch recording 2, count the start points to number 2. The total is 3. Enter 3 in step "3" and press REW.

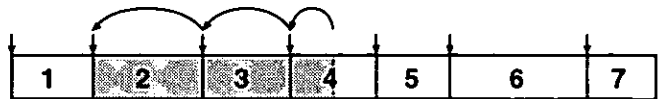

Example 2:

If you are watching recording 2 and you want to watch recording 6, count the start points to number 6. The total is 4. Enter 4 in step "3" and press FF.



NOTE: ↓ indicates start points of each recording.

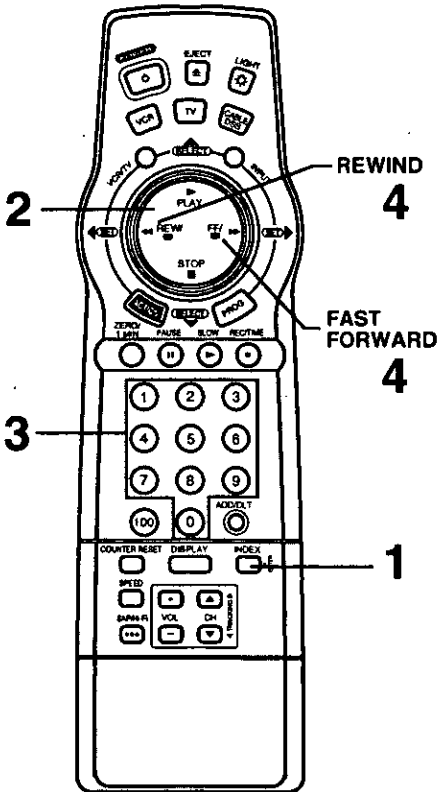
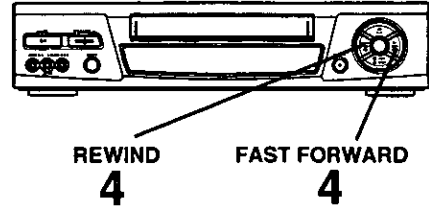

- Make each entry within 10 seconds, or the Index Search mode will be canceled.
- Index marks will be placed for Timer recordings as well.
- If any of the VHS Index Search System are initiated extremely close to an index mark, the index mark may not be counted in the search.
- In the Program Index Search mode, this VCR can memorize a total of 8 programs in order of recording. If you memorize more than 8 programs, the first program will be deleted and the new program will be listed.

Important for Program Index Search: Timer recordings must be recorded back to back in order for them to be placed on the Program Index list. If a timer recording is followed by a function, such as REW or PLAY, the data is lost.

Program Index Search (For timer recordings only)

This feature allows you to choose a timer recorded program from a Program Index list and then start a search for that program. Once the tape is ejected or normal recording is started, all program index data are deleted.

1 Press INDEX to display the "SELECT SEARCH MODE" screen.

2 Press ▲▼ to select "PROGRAM INDEX SEARCH," and then press ► to display the "PROGRAM INDEX" screen.

3 Press ▲▼ to select the desired recorded program, and then press ► to start the forward or rewind search.

- When the designated program is reached, the VCR automatically goes into Playback mode.

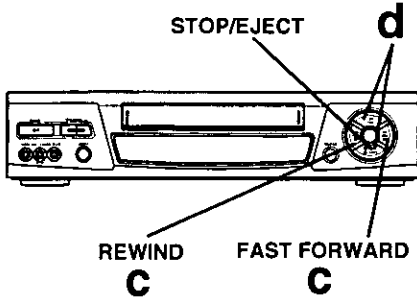
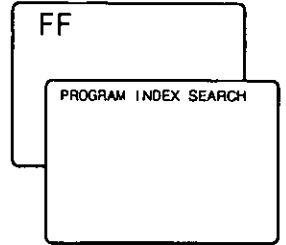
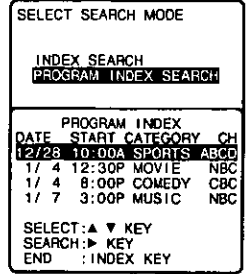

Index Scan

(For normal and/or timer recordings)

This feature allows you to scan (forward or reverse) each recording for 10 seconds in Playback mode.

a Press INDEX to display the "SELECT SEARCH MODE" screen.

- This screen appears only if there are timer recordings on the Program Index list. If this screen does not appear, go to step c.

b Press ▲▼ to select "INDEX SEARCH," and then press ► to display the "INDEX" screen.

c Press REW or FF to begin the scan.

- As each index mark is reached, a short playback will be performed after which FF or REW resumes.

d Press PLAY to cancel the scan and begin playback.

- You may also press STOP to stop the tape.

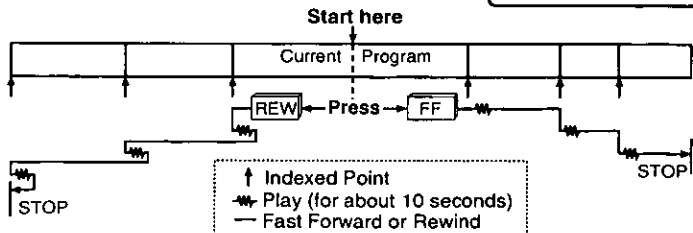
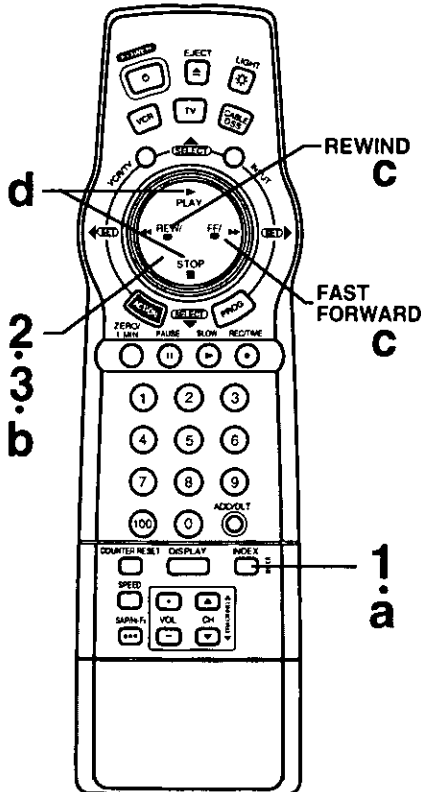
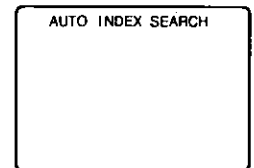
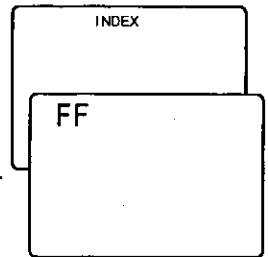
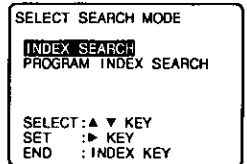

Tape Operation (continued)

***Important:** If the remote control POWER, ACTION, PROG, CH▲/▼, INDEX or ADD/HLT button does not work when pressed, press the VCR button on the remote and try the button again.

Your VCR is equipped with several time saving features as well as convenient automatic functions making tape operation easier than ever.

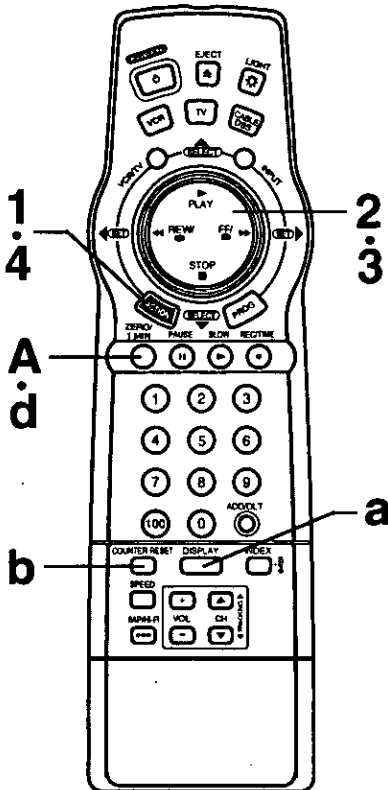

Repeat Play

The VCR will play your recording over and over.

1 Press **ACTION*** to display the menu.

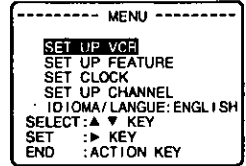

2 Press **▲▼** to select "SET UP VCR," and then press **►** to display the "SET UP VCR" screen.

3 Press **▲▼** to select "REPEAT PLAY," and then press **►** to select "ON" or "OFF."

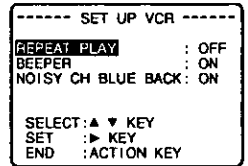

- When "ON" is selected, the VCR plays the tape to its end or until a blank portion of over 30 seconds is detected (erased portions are not considered blank). The tape is then rewound and played again and again until Repeat Play is turned off.

4 Press **ACTION** twice to return to the normal screen.

One Minute Skip

The VCR rapidly skips over one minute of tape.

A Press **ZERO/1 MIN** in Play mode.

- The VCR will go into FF search mode and skip over 60 seconds of recorded time. Normal playback will then resume.

Auto Operation Functions

Auto Playback

When a tape is inserted, the power turns on (Auto). If the record tab* is removed, playback begins (Auto).

Auto Rewind

When a tape reaches its end during playback, fast forward or manual record, the VCR will rewind and go into Stop mode.

Playback Auto Eject (Repeat Play is "OFF.")

When a tape without a record tab* is played to its end, the VCR will rewind and then eject the tape.

Memory Rewind Off

When the POWER button is pressed during rewind, the VCR will turn off after rewind is complete.

* For record tab information, see page 5.

Zero Search

To quickly return to a specific tape location.

a Press **DISPLAY** to display the Time Counter overlay during playback.

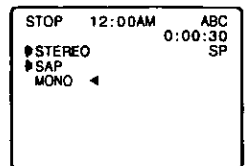

b Press **COUNTER RESET** to reset the Time Counter to "0:00:00" at the desired position.

c Continue playback, rewind, or fast forward.

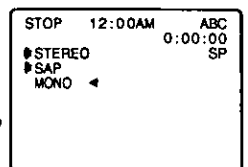

d Press **ZERO/1 MIN** in Stop mode when you want to return to "0:00:00."

- The VCR will go into FF or REW mode and stop at the last point the Time Counter was set to 0:00:00.



Special VCR Features

Check list before you begin.

- All connections are made. (See pages 6-9.)
- VCR is plugged in.
- TV is turned on and set to the VCR channel (CH 3 or 4).

VCR Lock Feature

When activated, this feature prohibits all operations except for timer recording and tape eject. This feature may be used to keep young children from operating the VCR.

Hold down **REC/TIME** on the VCR without a cassette inserted for **7 seconds** during Power On mode.

- **"NO CASSETTE PLEASE INSERT A CASSETTE"** is displayed when REC/TIME is pressed. Please disregard this warning and continue to hold down REC/TIME for 7 seconds.

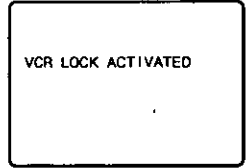

To Cancel the VCR Lock feature, with or without a cassette inserted, hold down REC/TIME on the VCR for 7 seconds again while in Stop mode.

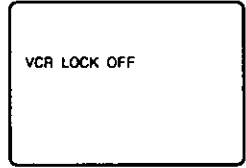

- VCR Lock mode is cancelled automatically after about 24 hours as long as the clock is set.

Warning Beeper Feature

When you select BEEPER ON, a short warning will sound each time an invalid entry or incomplete operation is made.

1 Press **ACTION** to display the menu.

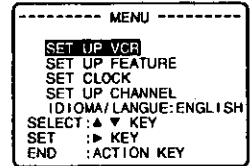

2 Press **▲▼** to select "SET UP VCR," and then press **▶** to display the "SET. UP VCR" screen.

3 Press **▲▼** to select "BEEPER," and then press **▶** to select "ON" or "OFF."

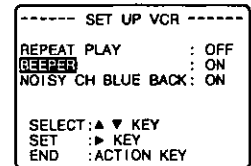

4 Press **ACTION** twice to exit this screen.

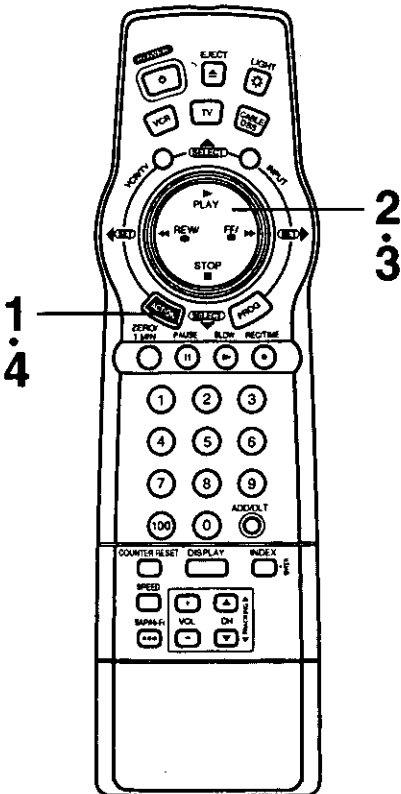
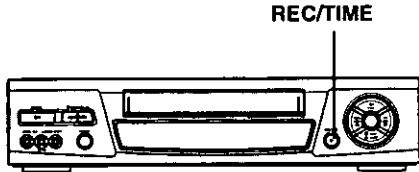

More You Can Do



Special VCR Features

***Important:** If the remote control POWER, ACTION, PROG, CH▲/▼, INDEX or ADD/DLT button does not work when pressed, press the VCR button on the remote and try the button again.

Channel Caption

You can set channel names, i.e. ABC, CBS, so that when selected, the channel name and number appear on-screen for easy identification. You can go with preset names (up to 24), or manually create your own (up to 10).

Note: You will need a list of channels received in your area and the channel numbers you receive them on.

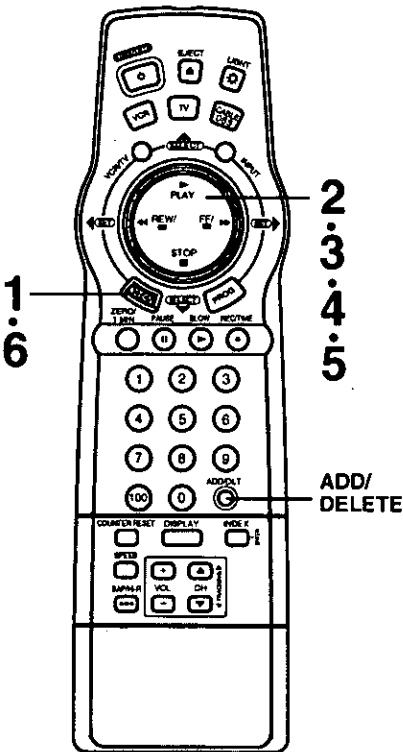

Preset Caption

1 Press ACTION* to display the menu.

```
----- MENU -----
SET UP VCR
SET UP FEATURE
SET CLOCK
SET UP CHANNEL
ID10M/LANGUE:ENGLISH
SELECT:▲▼KEY
SET:▶KEY
END:ACTION KEY
```

2 Press ▲▼ to select "SET UP CHANNEL," and then press ▶ to display the "SET UP CHANNEL" screen.

```
---- SET UP CHANNEL ----
ANTENNA : CABLE
AUTO SET
CHANNEL CAPTION
CABLE/DSS BOX SET UP
VCR Plus+ CH SET UP
SELECT:▲▼KEY
SET:▶KEY
END:ACTION KEY
```

3 Press ▲▼ to select "CHANNEL CAPTION," and then press ▶ to display the "CHANNEL CAPTION" screen.

```
--- CHANNEL CAPTION ---
PRESET CAPTION
MANUAL CAPTION

SELECT:▲▼KEY
SET:▶KEY
END:ACTION KEY
```

4 Press ▲▼ to select "PRESET CAPTION," and then press ▶ to display the "PRESET CAPTION" screen.

- You can set up to twenty-four channel captions. If you want to set a station name other than these, go to the "Manual Caption" section below.

5 Press ▶ to move the shaded area to the right side. Then, press ▲▼ to change the memorized channel number to match the caption.

```
--- PRESET CAPTION ---
ABC -- PBS --
CBS -- CNN --
FOX -- ESPN --
NBC -- HBO --

SELECT:▲▼KEY
SET:▶KEY
END:ACTION KEY
```

Next, press ◀ to set the memorized channel number.

Now, press ▲▼ to continue.

Repeat step 5 until the Caption List is complete.

```
--- PRESET CAPTION ---
TNT - 42  CBC  62
UPN  -- CTN  21
WB   35  TSN  52
DSC  -- GLOB 123

CLEAR :ADD/DLT KEY
SELECT:▲▼KEY
SET:◀KEY
END:ACTION KEY
```

To Make Corrections

Press ▲▼ and ▶ to select the memorized channel number.

Then, press ▲▼ to change, or ADD/DLT to delete the channel number.

6 Press ACTION four times to exit this mode and return to the normal screen.

Manual Caption

a Follow steps 1-3 in the "Preset Caption" section on page 28.

b In step 4, press $\blacktriangle/\blacktriangledown$ to select "MANUAL CAPTION," and then press \blacktriangleright to display the "MANUAL CAPTION" screen.

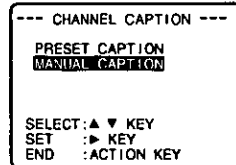

c Press $\blacktriangle/\blacktriangledown$ to select "CH NUMBER," and then press \blacktriangleright to move the shaded area to the right.

- Channels already set in the "Preset Caption" section and channels deleted from Channel Memory are not displayed.
- You can set a total of ten channel captions with up to four characters each.

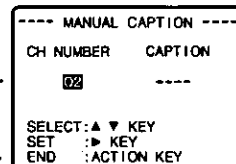

d Press $\blacktriangle/\blacktriangledown$ to select, and then press \blacktriangleright to enter each character of the caption.

- Characters will change in the following order.

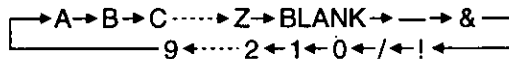

Now, press \blacktriangleleft repeatedly to move the cursor back to CH NUMBER. Repeat steps "c" and "d" as desired.

To Make Corrections, repeatedly press \blacktriangleright to move the cursor to the right, or \blacktriangleleft to move to the left to the incorrect entry and make the correction.

To Clear the Caption, press ADD/DLT.

e Press ACTION four times to exit this mode and return to the normal screen.

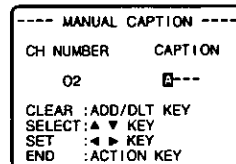
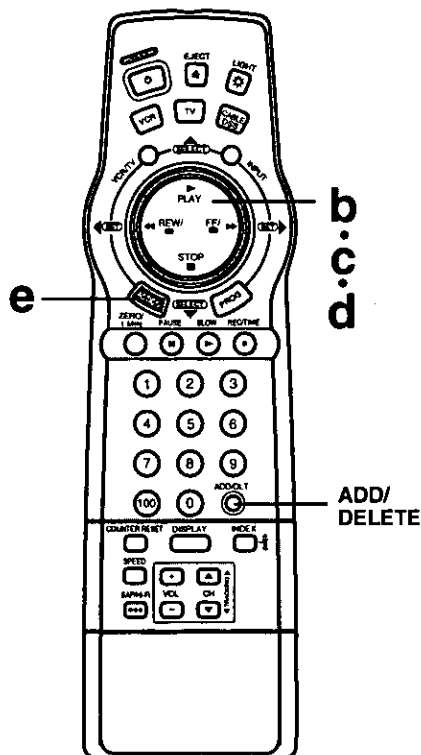

Special VCR Features (continued)

*Important:

If the remote control POWER, ACTION, PROG, CH▲▼, INDEX/ M/A SKIP or ADD/HLT button does not work when pressed, press the VCR button on the remote and try the button again.

- Check list before you begin.
- Clock is set to correct time.

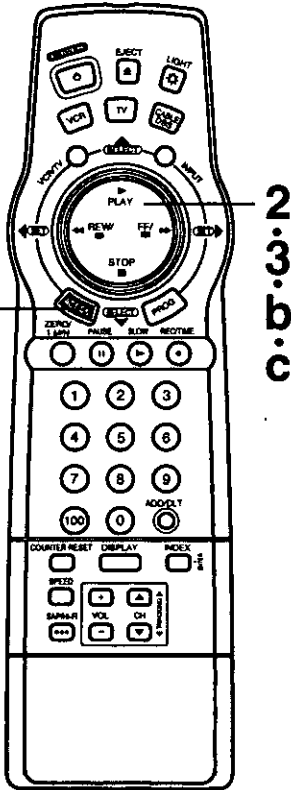

Time Stamp Feature

For about the first 10 seconds of each recording, the VCR automatically writes the following program data on the tape: Date, Start time, Scheduled stop time (for Timer Rec. only), Channel No. and Category (for Timer Rec. only). Then, if playback is started at the starting point of the recording, this information will be displayed about 7 seconds after playback begins for a few seconds.

1 Press ACTION* to display the menu.

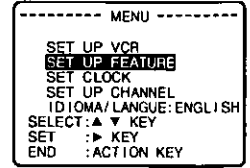

2 Press ▲▼ to select "SET UP FEATURE," and then press ► to display the "SET UP FEATURE" screen.

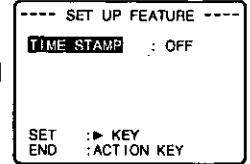

3 Press ▲▼ to select "TIME STAMP," and then press ► to select "ON" or "OFF."

- When "OFF" is selected, the program data is written on the tape, but will not be displayed for the first 7 seconds of playback.

4 Press ACTION twice to exit.

<Time Stamp Example>

Normal/

One Touch Recording

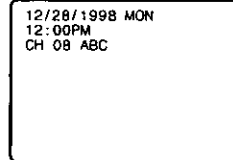

Timer Recording

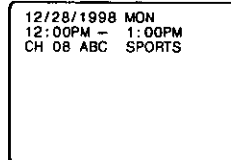

When Clock is not set...

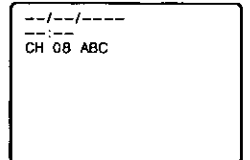

- If the tape speed is changed immediately after recording begins, the display may be incorrect.

Blue Back ON/OFF Feature

You may choose whether or not you want the VCR to display a solid blue screen when the broadcast signal is very weak or nonexistent.

a Press ACTION to display the menu.

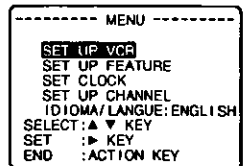

b Press ▲▼ to select "SET UP VCR," and then press ► to display the "SET UP VCR" screen.

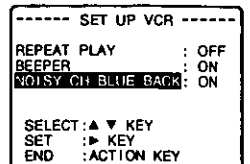

c Press ▲▼ to select "NOISY CH BLUE BACK," and then press ► to select "ON" or "OFF."

- When "ON" is selected, a solid blue screen appears whenever the signal is weak or nonexistent. When "OFF" is selected, the picture is displayed regardless of the signal condition.
- The picture can not always be seen clearly when "OFF" is selected.

d Press ACTION twice to exit.

NOTE • When the VCR is connected to a Combination VCR which has a Blue Back feature, even if the VCR Blue Back is set to "OFF" on the VCR, the screen will go to a blue background.



Copying Your Tapes (Dubbing)

Connections you'll need to make. (Choose front or rear connection.)

- When connecting to a normal VCR, use the L Audio In jack for proper sound reproduction.

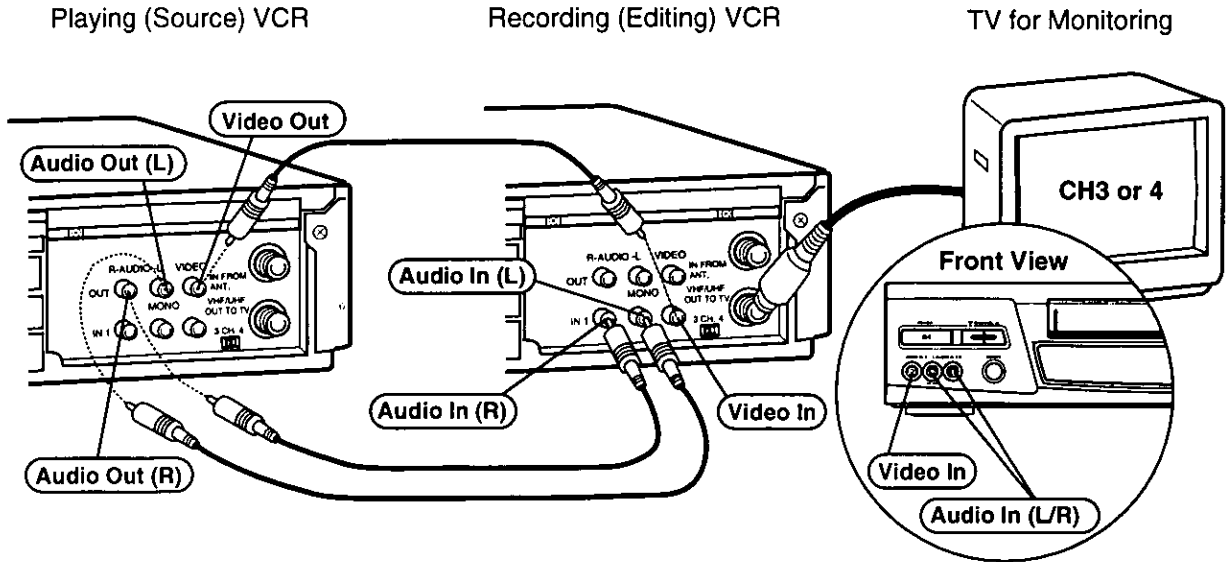

- 1 Insert a pre-recorded tape into the Playing (Source) VCR.

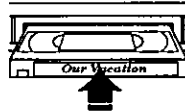

- 2 Insert a blank tape with record tab into the Recording (Editing) VCR.

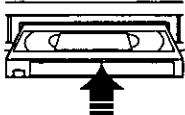

- 3 Select "LINE" Input mode on the Recording (Editing) VCR. (See "Selecting the Input Mode" on page 21.)

- 4 Press **PLAY** on the Playing VCR. Press **PAUSE** at the desired starting point.

- 5 Press **REC** on the Recording VCR, and then press **PAUSE** immediately thereafter.

- 6 Press **PAUSE** on both VCRs at the same time, to begin copying.

To Edit Out Unwanted Parts

Press **PAUSE** on the recording VCR while copying is in progress. Press **PAUSE** again to resume copying.

- 7 Press **STOP** on both VCRs to stop copying.

To Monitor Dubbing on Your TV

- 1 Turn your TV on and tune to the Recording VCR channel (CH3 or CH4).
- 2 Set the VCR/TV Selector on the Recording VCR to "VCR."

Caution:

Unauthorized exchanging and/or copying of copyrighted recordings may be copyright infringement.

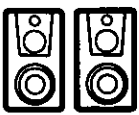

MTS Broadcast/ VHS Hi-Fi Stereo System

✓ Check list before you begin.

- The VCR is connected to a stereo TV, or a mono TV and an external stereo amp or receiver with speakers.
- The VCR and other components are plugged in and turned on.

Connections to Make

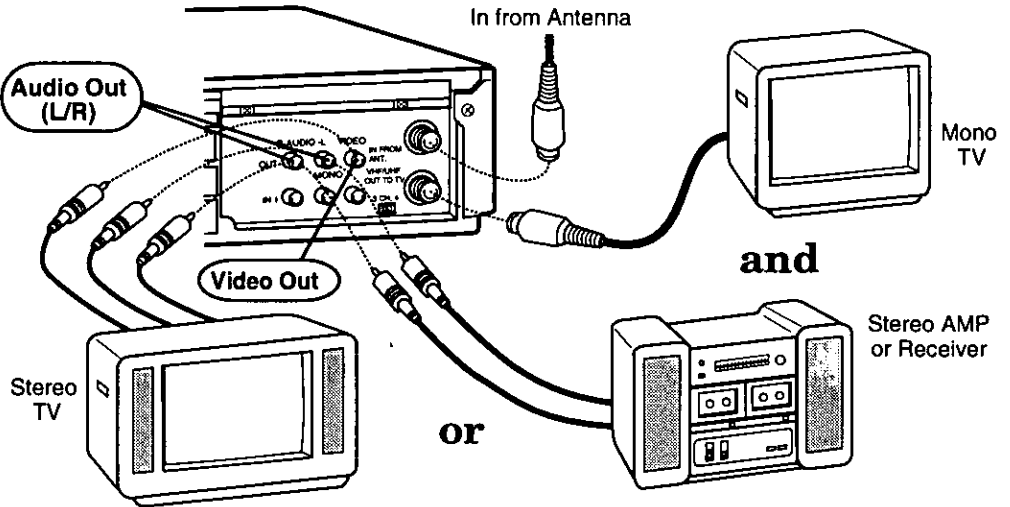

When recording, you may monitor in stereo, by connecting the VCR to either a stereo TV, or a mono sound TV with an external stereo amp and speakers.

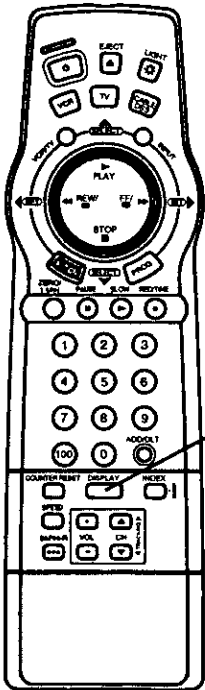

DISPLAY

Receivable Broadcast Types

The following are possible audio broadcast types and on-screen displays. The signal being received is indicated with an "k" mark while the selected audio mode is indicated with an arrow.

Press **DISPLAY** to display the broadcast signal currently being received.

MTS Stereo and SAP broadcast

Multi-channel Television Sound Stereo (main language) and Secondary Audio Program (sub language) broadcasts are being received simultaneously. Select STEREO or SAP audio mode.

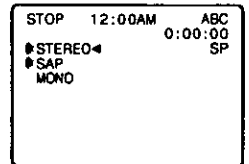

MTS Stereo broadcast

Multi-channel Television Sound Stereo broadcast. Select STEREO audio mode.

- If a stereo broadcast is weak and the display flickers, you may want to select the MONO audio mode for better results.

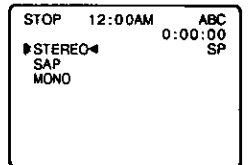

SAP broadcast

Secondary Audio Program (sub language) broadcast. Select SAP audio mode for the sub language.

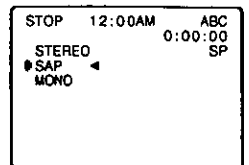

MONO broadcast

Normal monaural sound broadcast.

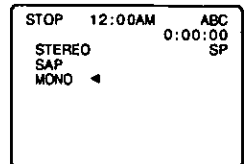

Equipped with **dbx**® -TV Noise Reduction for true MTS reproduction. **dbx**® -TV Noise Reduction is required for good stereo separation and audio fidelity. **dbx**® is a registered trademark, and is licensed by **dbx**® Technology Licensing.

With the proper audio mode setting, your VCR can:

- 1) record and playback an MTS stereo broadcast (main language) in stereo Hi-Fi.
- 2) record and playback a monaural broadcast (main language) or Secondary Audio Program (sub language) on the Hi-Fi tracks for better quality monaural sound.
- 3) playback non Hi-Fi tapes in monaural.

- When recording, the selected broadcast sound is always recorded on the left and right Hi-Fi tracks as well as the normal monaural track. This means your tapes can be played back on Hi-Fi as well as non-Hi-Fi VCRs.

Audio Mode for Recording

1 Press **SAP/Hi-Fi** repeatedly (each press within 5 seconds) to select the desired audio mode (STEREO, SAP, or MONO).

- Please refer to the "Receivable Broadcast Types" section on page 32.

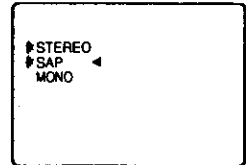

- The arrow indicates your selection.

2 Do a recording. See the "Record On a Tape" section on page 20.

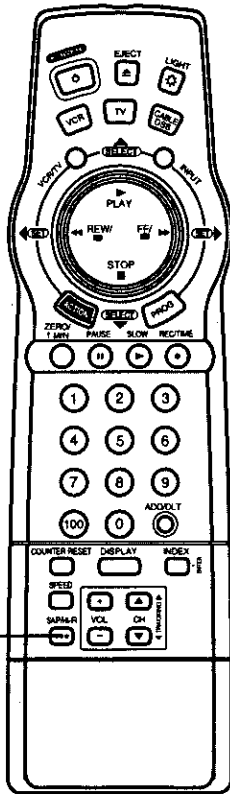

Audio Mode for Playback

a Playback the tape. See the "Playback a Tape" section on page 19.

b Press **SAP/Hi-Fi** repeatedly (each press within 5 seconds) to select the desired audio mode (HIFI or NORMAL).

- Select "HIFI" to listen to your stereo recordings with stereo sound, or "NORMAL" for monaural sound.

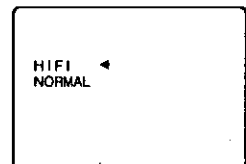

- The arrow indicates your selection.



- When purchasing or renting prerecorded tapes, remember that only those recorded in Hi-Fi stereo will play back with true stereo sound. Standard stereo tapes will play back with monaural sound.
- In order to listen to Hi-Fi stereo playback, the VCR AUDIO (L/R) jacks must be connected to a stereo TV or an external stereo amp and speakers. (See page 32.)
- When adjusting the tracking during playback, the Hi-Fi audio sound may revert to normal audio sound. This is normal.
- There may be a difference in audio level between Hi-Fi and normal audio playback.

More You Can Do

***Important:** If the remote control POWER, ACTION, PROG, CH▲▼, INDEX or ADD/DLT button does not work when pressed, press the VCR button on the remote and try the button again.

In order for the VCR to read the VCR Plus+ code, some set up is required. A Guide (VCR Plus+) channel number is assigned to each local broadcast and cable station. Because this number sometimes differs from the channel your TV receives the station on, it is necessary to program the VCR with local channel information.

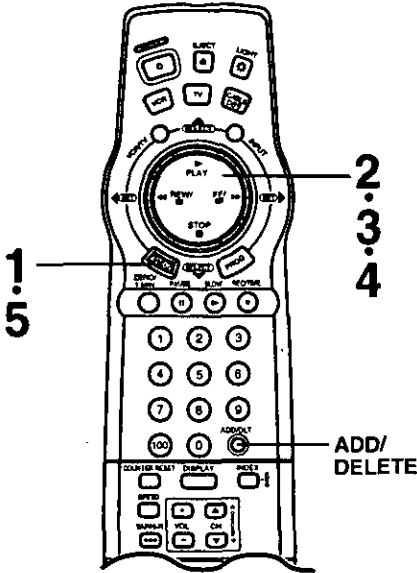

Channel Setup Preparations

NOTE: Complete the steps on this page if your cable box can be controlled with the VCR, or your VCR hook-up resembles "B" on page 12.

Prepare a list like the example below.

This list will help you smoothly enter the information needed in step "4" at right.

You will need the following to complete the list:

- A line up of normal and/or cable stations you receive along with the channel numbers your TV receives them on. A cable channel line-up chart is supplied by your cable company.
- A list of Guide (VCR Plus+) channel numbers assigned to the stations you receive. This list is available in *TV Guide* and the TV listings found in selected newspapers.

- 1 Make a chart with 3 columns like the example below. In the left column, fill in the name or call letters of the stations you receive.
- 2 In the middle column, fill in each station's assigned Guide (VCR Plus+) number found in *TV Guide*, newspapers, etc.
- 3 In the right column, fill in the channel number that your TV receives the station on from your channel line-up.

EXAMPLE ONLY

Broadcast or Cable Station Name	Assigned Guide (VCR Plus+) channel no.	Channel no. your TV receives the station on
HBO	33	15
Nickelodeon	38	20
CBS	04	04
FOX	11	

VCR Plus+ Channel Setup

Complete this page only if Type B connection method (pg. 12) is used.

- Before you begin, complete the Channel Setup Preparations below left.

Important Note:

If your VCR connection type changes from type A to B, perform "To Setup the VCR in Case a Cable Box or DSS Receiver was Installed or Replaced" section on page 17 before proceeding with these steps.

- 1 Press **ACTION*** to display the menu.

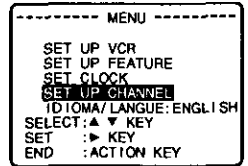

- 2 Press **▲▼** to select "SET UP CHANNEL," and then press **▶** to display the "SET UP CHANNEL" screen.

- 3 Press **▲▼** to select "VCR Plus+ CH SET UP," and then press **▶** to display the "VCR Plus+ CH SET UP" screen.

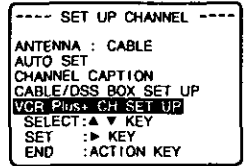

IMPORTANT NOTE:

For step "4," use the list you prepared. You may leave lines blank if you don't receive that station, or if the **GUIDE CH** number and the **CABLE (or TV) CH** numbers are the same.

- 4 Press **▶** to move the shaded area to the right side.

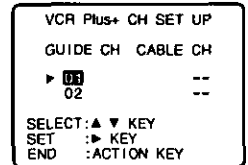

Then, press **▲▼** to change CABLE or TV CH number.

Next, press **◀** to set the number.

Now, press **▲▼** to continue.

Repeat this operation until the list is complete.

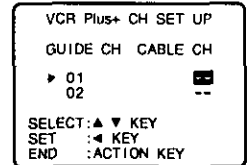

To Enter More Programs

Press **▲▼** and **▶** to select the incorrect CABLE or TV CH number. Then, press **▲▼** to change, or **ADD/DLT** to delete the channel.

- 5 Press **ACTION** three times to exit the VCR Plus+ CH SET UP mode.



- Make each entry within 5 minutes or the VCR will leave this mode.
- Once local channels have been programmed, they will stay in memory, even in the case of a power failure.

VCR Plus+C³ and PlusCode are trademarks of Gemstar Development Corporation. The VCR Plus+ system is manufactured under license from Gemstar Development Corporation.

- Check list before you begin.
- The clock is set.
- VCR Plus+ Setup is complete (see page 34).



9 Multi Function Display

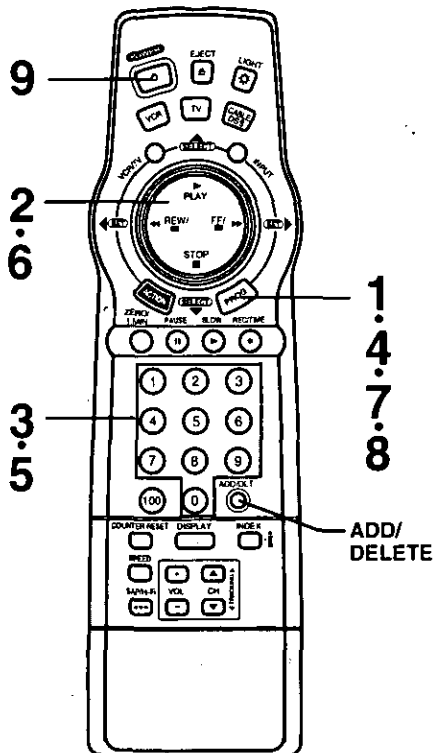

ADD/DELETE

1 Press **PROG** to display the "SET PROGRAM" screen.

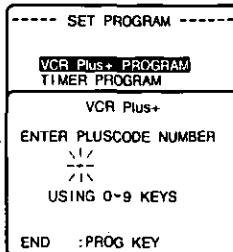

2 Press **▲▼** to select "VCR Plus+ PROGRAM," and then press **▶** to display the "VCR Plus+" screen.

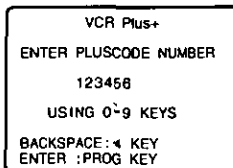

3 Press the **NUMBERED** keys to enter the PlusCode number.

- Refer to your local TV listings.

To Make Corrections

Press **◀** repeatedly to delete the PlusCode number. Then, enter the correct number.

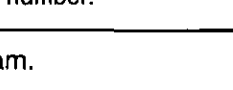

4 Press **PROG** to lock in your program.

5 Press the **1, 2 or 3** key to select the program type.

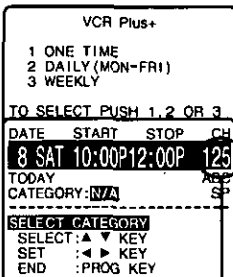

6 Press **▲▼** and **▶** to select and set each of the remaining items as follows.

- Remaining Items**
- Category (N/A [not applicable], SPORTS, MOVIE, COMEDY, MUSIC, DRAMA)
 - Speed (SP, LP, SLP)

To Make Corrections

Repeatedly press **▶** to move the cursor to the right, or **◀** to move to the left to the incorrect entry and make the correction.

- If you use connection type "A" on page 12, the channel shown in this on-screen display will always be the cable box output channel number.

7 Press **PROG** if contents are acceptable.

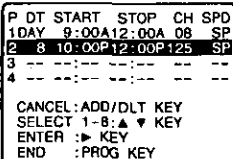

To cancel program contents:
Press **ADD/DLT**.

CANCEL: ADD/DLT KEY
SELECT 1-8: ▲ ▼ KEY
ENTER: ▶ KEY
END: :PROG KEY

8 Press **PROG** to complete the program.

- If you're using a Cable Box, make sure that it is tuned to the desired channel and the power is left on for timer recording.

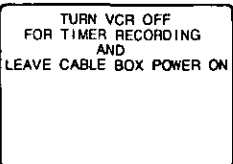

- This display may differ depending on your cable box hook-up.

9 Press **POWER** off to set the timer.



Multi Function Display

Use normal Timer Recording steps if:

- the PlusCode for a program is not listed.
- you anticipate the program, such as a sporting event, to run over the scheduled stop time.

See page 23 to:

- cancel a timer recording in progress.
- replace program contents.
- review or clear program contents once set.

Important notes when using a DSS receiver

- When recording programs via a DSS receiver, the DSS receiver must be left on.
- When recording programs via an antenna or cable, the DSS receiver must be turned off.



- You can obtain unlisted PlusCode numbers by calling 1 - 900 - 454 - 7587. Call costs approximately \$.95 per minute.
- VCR PlusCodes can not be used to program the VCR to record DSS channels.
- Avoid overlapping program times.
- An on-screen display will indicate if an invalid PlusCode number has been entered or when all timer programs are full.

More You Can Do



Multi-Brand Control Feature

The Remote Control may be set up to control some of the functions on your TV or Cable Box.

TV Brand Code Numbers	
Panasonic	01, 02
Quasar	01, 02
RCA	03
GE	03
Zenith	04
Magnavox	05
Sylvania	05
Sharp	06, 07
Sony	08
Toshiba	09
Sanyo	10
Fisher	10
JVC	11
Hitachi	12
Mitsubishi	07, 13
Samsung	14
Gold Star	15, 16, 17

DSS Brand Code Numbers	
Toshiba	103
Hitachi/ Hughes	104
Magnavox/ Uniden 1	105
Magnavox/ Uniden 2	106
Sony	107
RCA	108
Panasonic	109

Cable Box Brand Code Numbers	
Archer	01, 29, 44, 88, 91
Cableview	04, 30, 42, 44, 52, 63, 85, 88
Citizen	04, 30, 42, 44, 52, 63, 85, 88
Curtis	08, 09, 56, 61, 87, 90
Diamond	01, 29, 44, 88, 91
Drake	37, 67, 71
Eagle	13, 20, 22, 26, 40, 58, 62, 98
Eastern	28
GC Brand	04, 30, 42, 44, 52, 63, 85, 88
Gemini	04, 85
General Electric	57
General Instruments	01, 02, 03, 04, 34, 55, 83, 85, 91, 93, 95
Hamlin	14, 15, 28, 41, 97, 100, 102
Hitachi	31, 79
Jerrold	01, 02, 03, 04, 34, 55, 83, 85, 91, 93, 95
Macom	31, 79
Magnavox	25, 26
Matsushita	16, 17, 101
Movieltime	29, 32, 38, 39, 40, 42, 44, 88
NSC	32, 38, 40
Oak	10, 11, 46, 99
Panasonic	16, 17, 101
Philips	13, 20, 23, 24, 96
Pioneer	05, 06, 78
Pulsar	04, 30, 42, 44, 52, 63, 85, 88
Radio Shack	44
RCA	16, 17, 101
Realistic	44, 51, 88
Regal	14, 41
Regency	28
Rembran	29, 32, 39, 42, 44, 88
Salora	68, 72
Samsung	32, 40, 42, 78, 94
Scientific Atlanta	08, 09, 56, 61, 87, 90
Sheritech	27
SL Marx	32, 40, 42, 78, 94
Spucer	16, 17, 101
Stargate	04, 30, 32, 40, 42, 44, 52, 63, 78, 85, 88, 94
Sylvania	19
Teknika	74
Telecaption	77, 92
Televue	32, 40, 42, 78, 94
Texscan	18, 19
Tocom	01, 33, 34, 42, 48, 49, 91
Toshiba	36
Uniden Satellite	65, 69
Unika	01, 29, 44, 88, 91
Universal	42, 43, 44, 52, 63, 88
Viewstar	13, 20, 22, 26, 40, 58, 62, 98
Videoway	07, 23, 50
Vid Tech	64
Vidter	64
Zenith	07, 23, 50

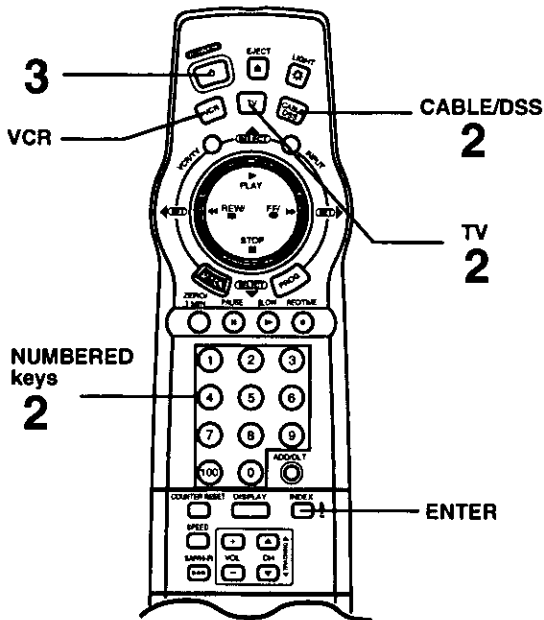

Multi-Brand Control Setup

- 1 Find your TV or Cable Box or DSS Box Brand Code Number from one of the charts on this page.
- 2 Hold down TV or CABLE/DSS. Use the NUMBERED keys to enter your TV or Cable Box Brand code number.
 - For code numbers 100 or greater, first press the 100 key. Then, enter the remaining digit. E.g. for 102, press 100, then press 2.
- 3 To confirm that the correct code was entered, press POWER to turn your TV or Cable Box or DSS Box On/Off.
- 4 Try each of the functions listed on page 37.
 - Due to changes in infra-red commands used by some manufacturers, more than one code may be listed for some TV or Cable Box brands. If your TV or Cable Box does not respond to the first code, please try entering the next code.

NOTES

- Please repeat the TV/Cable Box Set Up procedure when you replace the remote's batteries.
- The remote control is designed to control the brands listed. However, it will not operate all TVs, Cable Boxes or DSS Boxes made by these manufacturers. If you get no results, your particular product brand cannot be controlled by this remote control.

Using the Multi-Brand Control

Once the remote control has been properly set up, you can select VCR, TV, or CABLE/DSS mode depending on which functions you wish to control.

Press **VCR** or **TV** or **CABLE/DSS** on the remote control to select the desired mode. (See below for the controllable functions of each mode.)

NOTE:

In TV or CABLE/DSS mode, it may be necessary to press ENTER after pressing NUMBERED keys for channel selection.

VCR Mode

In VCR mode, the following buttons are available.

VCR

All function buttons.

TV

VOL UP/DOWN

TV Mode

In TV mode, the following buttons are available.

TV

POWER, INPUT, NUMBERED keys, ENTER, CH UP/DOWN, VOL UP/DOWN

VCR

EJECT, LIGHT, VCR/TV, PLAY, STOP, FF, REW, PAUSE, ZERO/1 MIN, SLOW, REC, SAP/Hi-Fi, SPEED, COUNTER RESET, DISPLAY

CABLE/DSS Mode

In CABLE/DSS mode, the following buttons are available.

CABLE/DSS

POWER, NUMBERED keys, ENTER, CH UP/DOWN

TV

VOL UP/DOWN

VCR

EJECT, LIGHT, VCR/TV, PLAY, STOP, FF, REW, PAUSE, ZERO/1 MIN, SLOW, REC, SAP/Hi-Fi, SPEED, COUNTER RESET, DISPLAY

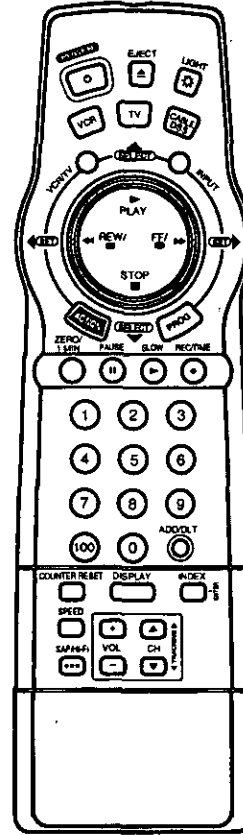
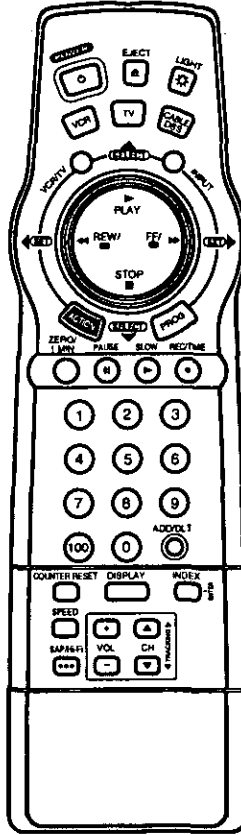
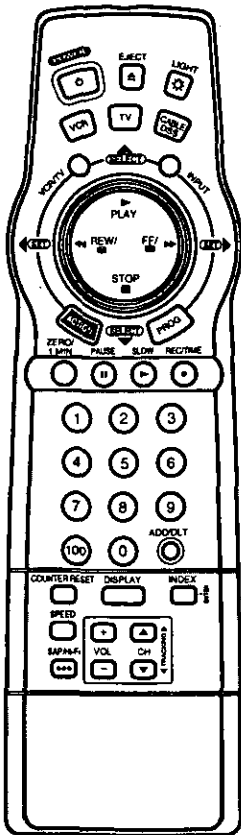

More You Can Do

NOTES

- Some TV, Cable Box and DSS Box brands require you to turn on the power manually.
- Not all functions listed may be controlled by this remote control.



Before Requesting Service

Check the following points once again if you are having trouble with your VCR.

Power	Correction
No power...	<ul style="list-style-type: none">• Completely insert the Power Plug into an AC outlet.• Set the POWER button to ON.
Recording & Playback	Correction
TV program cannot be recorded...	<ul style="list-style-type: none">• Check connections between VCR, external antenna, and your TV.• Make sure your antenna system (CABLE or TV) is correctly set. (To Replace Channels in Memory [P.17])• Make sure that the record tab is intact on the cassette. (P.5)
Timer recording cannot be performed...	<ul style="list-style-type: none">• Set the recording start/stop times correctly. (P.22)• Make sure that the POWER button is set to OFF. (P.22)• Timer recording may not be performed or continued if a power interruption of more than 1 minute occurs before, or during, a Timer Recording, even after power is restored.
There is no playback picture, or the playback picture is noisy or contains streaks...	<ul style="list-style-type: none">• Select channel 3 or 4 on the TV to match the Channel 3/4 switch located on the rear panel of the VCR. (P.6)• Set the VCR/TV selector to "VCR."• Check that channel 3 or 4 of the TV is properly tuned in.• Adjust the TRACKING control in either direction. (P.19)
Special effects playback, picture may contain some vertical jitter when using a TV with an Automatic Vertical Hold Control...	<ul style="list-style-type: none">• Set the TV's Vertical Hold Control to "MANUAL" and then adjust it.
VCR cannot be controlled...	<ul style="list-style-type: none">• Make sure that VCR LOCK is set to off. (P.27)
Remote Control	Correction
VCR cannot be remote controlled...	<ul style="list-style-type: none">• Aim the Remote Control directly at the remote sensor on the VCR. (P.10)• Avoid all obstacles which may interfere with the signal path.• Inspect the remote batteries for possible replacement. (P.4)• Make sure that VCR LOCK is set to off. (P.27)• Exposing the VCR remote sensor to direct fluorescent or outdoor light may cause signal interference.
ACTION and PROG buttons cannot be used...	<ul style="list-style-type: none">• Press the VCR button to select VCR mode. (P.37)
Miscellaneous	Correction
Programs cannot be viewed on TV...	<ul style="list-style-type: none">• Set the VCR/TV selector to "TV." (P.21)
Video cassette cannot be inserted...	<ul style="list-style-type: none">• Insert the cassette with window side up; record tab facing you.
Video cassette cannot be removed...	<ul style="list-style-type: none">• Completely insert the Power Plug into an AC wall outlet.
Video cassette ejects when a recording is started or the power is turned off for timer recording...	<ul style="list-style-type: none">• Make sure the record tab is intact on the cassette. (P.5)
In Stop mode, the motor (CYLINDER) continues to rotate...	<ul style="list-style-type: none">• To enable the quick play mechanism, the cylinder will rotate for about 5 minutes. This reduces response time from Stop to Play mode from Play to Rewind Search mode.
The top of the playback picture waves back and forth excessively...	<ul style="list-style-type: none">• Because the VCR playback signal is not as stable as an off-the-air TV signal, the top of your TV screen may be bent or unstable during playback. Slowly turn the horizontal hold control on your TV to correct the wavy picture. If your TV does not have a horizontal hold control or adjusting the control does not help, please contact your local TV service center.

Warranty

Panasonic Consumer Electronics Company,
Division of Matsushita Electric Corporation
of America,
One Panasonic Way
Secaucus, New Jersey 07094

Panasonic Sales Company,
Division of Matsushita Electric of Puerto Rico, Inc.
AVE. 65 de Infantería, Km. 9.5
San Gabriel Industrial Park
Carolina, Puerto Rico 00985

PANASONIC Video Products Limited Warranty

Panasonic Consumer Electronics Company or Panasonic Sales Company (collectively referred to as "the Warrantor") will repair this product with new or refurbished parts, free of charge, in the USA or Puerto Rico, in the event of a defect in materials or workmanship as follows (all time periods commence from the date of the original purchase):

PRODUCT	PARTS	LABOR
CAMCORDER	ONE (1) YEAR, EXCEPT CCD IMAGE SENSOR CCD IMAGE SENSOR - SIX (6) MONTHS	NINETY (90) DAYS NINETY (90) DAYS
VCR	ONE (1) YEAR	NINETY (90) DAYS
A/V MIXER	ONE (1) YEAR	NINETY (90) DAYS
MONITOR-VCR	ONE (1) YEAR, EXCEPT CRT CRT - TWO (2) YEARS	NINETY (90) DAYS CRT - NINETY (90) DAYS CUSTOMER PAYS ALL LABOR CHARGES AFTER 90 DAYS

**Monitor-VCR In-home or carry-in Service: 22" (diagonal) CRT / LCD and Larger
Monitor-VCR Carry-in Service: 21" (diagonal) CRT / LCD and smaller**

Batteries (if included) - New rechargeable batteries in exchange for defective rechargeable batteries for ten (10) days. Non-rechargeable batteries are not warranted.

Tape (if included) - New video cassette tape in exchange for a defective video cassette tape for five (5) days.

In-home, carry-in or mail-in service, as applicable, in the USA can be obtained during the warranty period by contacting a Panasonic Services Company (PASC) Factory Servicenter listed in the Service Directory. Or call toll free 1-800-211-PANA (7262), to locate an authorized PASC Servicenter. Carry-in or mail-in service in Puerto Rico can be obtained during the warranty period by calling the Panasonic Sales Company telephone number listed in the Servicenter Directory.

This warranty is extended only to the original purchaser. A purchase receipt or other proof of the date of the original purchase is required before warranty service is rendered.

This warranty only covers failures due to defects in materials and workmanship which occur during normal use and does not cover normal maintenance, including, but not limited to, video and audio head cleaning. The warranty does not cover damage which occurs in shipment, or failures which are caused by products not supplied by the warrantor, or failures which result from accident, misuse, abuse, neglect, mishandling, misapplication, alteration, modification, faulty installation, set-up adjustments, improper antenna, inadequate signal pickup, maladjustment of consumer controls, improper operation, power line surge, improper voltage supply, lightning damage, commercial use such as hotel, office, restaurant, or other business or rental use of the product, or service by anyone other than a PASC Factory Servicenter or a PASC authorized Servicenter, or damage that is attributable to acts of God.

LIMITS AND EXCLUSIONS

There are no express warranties except as listed above.

THE WARRANTOR SHALL NOT BE LIABLE FOR INCIDENTAL OR CONSEQUENTIAL DAMAGES (INCLUDING, WITHOUT LIMITATION, DAMAGE TO TAPES) RESULTING FROM THE USE OF THIS PRODUCTS, OR ARISING OUT OF ANY BREACH OF THE WARRANTY. ALL EXPRESS AND IMPLIED WARRANTIES, INCLUDING THE WARRANTIES OF MERCHANTABILITY AND FITNESS FOR PARTICULAR PURPOSE, ARE LIMITED TO THE APPLICABLE WARRANTY PERIOD SET FORTH ABOVE. Some states do not allow the exclusion or limitation of incidental or consequential damages, or limitations on how long an implied warranty lasts, so the above exclusions or limitations may not apply to you.

This warranty gives you specific legal rights and you may also have other rights which vary from state to state.

If a problem with this product develops during or after the warranty period, you may contact your dealer or Servicenter. If the problem is not handled to your satisfaction, then write to the Customer Satisfaction Center at the Panasonic Consumer Electronics Company address above.

SERVICE CALLS WHICH DO NOT INVOLVE DEFECTIVE MATERIALS OR WORKMANSHIP AS DETERMINED BY THE WARRANTOR, IN ITS SOLE DISCRETION, ARE NOT COVERED. COSTS OF SUCH SERVICE CALLS ARE THE RESPONSIBILITY OF THE PURCHASER.

warvid 10/20/97

**Thank you for your purchase.
For service of this Panasonic product, please contact your local Sears Service Center.
To locate the closest Sears Service Center, call 1-800-488-1222.**

Spanish Quick Use Guide/Guía para rápida consulta

Para ajustar el lenguaje, el sintonizador de cable/DSS, los canales y el reloj automático

1 Encienda el televisor y la videograbadora.

2 Sintonice el televisor al canal de salida de la videograbadora (el mismo canal que ha fijado en la parte trasera de la videograbadora; canal 3 o 4).

- Si esta usando los terminales de audio/video para su conexión, fije el televisor al modo de entrada de video.

3 Oprimir CH ▲ para elegir el idioma de la pantalla en inglés.

Oprimir CH ▼ para elegir el idioma de la pantalla en español.

Oprimir VCR/TV para elegir el idioma de la pantalla en francés.

- Ud. podrá fijar también usando los mismos botones que están ubicados en la videograbadora.
- La videograbadora debe conectarse a una antena o caja de TV por cable.

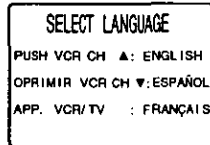

4 Oprimir ▲▼ para elegir, y luego oprimir ► para fijar su conexión.

- Si ud. ha elegido CABLE/DSS ► VCR ► TV, continúe al paso 5. De lo contrario, vaya a la sección "Instrucciones alternativas" en la página 16.
- Si está usando el método de conexión CABLE/DSS BOX ► VCR ► TV, sólo el canal de salida del cable será memorizado.

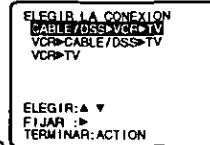

5 Oprimir ▲▼ para elegir el canal de salida de la caja de TV por cable o el receptor DSS, y luego oprimir ► para fijar.

- Si es necesario, consulte su manual de la caja de TV por cable.
- Si ud. está usando los terminales de audio/video para la conexión de la caja de TV por cable, elija y fije a "SALIDA DE VIDEO" para el canal de salida.

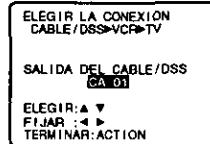

6 Oprimir ▲▼ para elegir el número de código de la caja de TV por cable o el receptor DSS, y luego oprimir ► para fijar. (Consulte su lista de la página 13.)

- Si su caja de TV por cable o su receptor DSS no tiene un control remoto, elija "SIN CONTROL REMOTO."
- Luego, vaya a la sección "Instrucciones alternativas" en la página 41.
- De esta manera se determina si el videograbador va a controlar el sintonizador de cable o DSS.

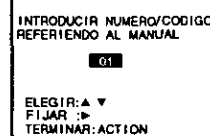

7 Si ud. usa una caja de TV por cable, sintonice al canal 2. Si usa un receptor DSS, sintonice al canal 270.

Oprimir ► para continuar.

- "ESTA TRANSMITIENDO" aparece.

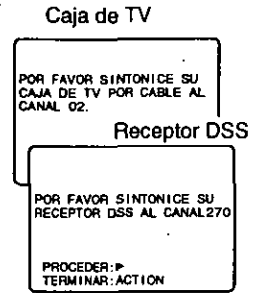

8 Oprimir ▲▼ para elegir "SI" o "NO," y luego oprimir ► para fijar.

Si ud. usa una caja de TV por cable y ha elegido "SI," siga al paso 9.

Si ud. usa un receptor DSS y ha elegido "SI," siga las instrucciones alternativas de la página 41.

Si ha elegido "NO," aparecerá de nuevo la pantalla del paso 6.

Intente fijar un código diferente para su marca y/o cambie la conexión de su equipo.

Si su respuesta es todavía "NO," el control de la caja de TV por cable o el receptor DSS no es disponible.

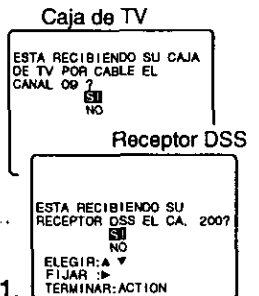

Verifique que su caja de TV por cable esté encendido y su receptor DSS esté apagado.

9 Oprimir ▲▼ para elegir el canal PBS de su local que está recibiendo en su caja de TV por cable, y luego oprimir ► para que aparezca la pantalla "FIJACION AUTO. (RELOJ)."

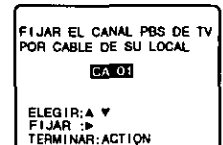

10 Oprimir CH ▲ para iniciar la fijación automática del reloj.

- Si ud. vive cerca de una zona con diferente hora, fije el canal de su zona.

- "FIJACION AUTOMATICA DE RELOJ EN PROCESO" aparece.

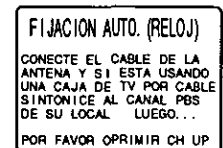

11 Esta pantalla aparece cuando la fijación automática del reloj es completo.

Comprobar si la hora está fijada correctamente y luego oprimir ▲ CH para terminar la fijación.

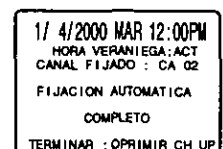

Si la hora fijada automáticamente es incorrecto

Si ud. usa una caja de TV por cable y recibe emisiones de más de un canal PBS, intente fijar automáticamente otravez. Siga la "Para fijar o fijar de nuevo el reloj" en la página 42 y cuando las instrucciones de la pantalla requiere la fijación del canal PBS, fije un canal que no ha intentado anteriormente.

Si aparece en la pantalla FIJACION DEL RELOJ INCOMPLETO

La pantalla a la derecha aparecerá si no es disponible en su zona la fijación automática de la hora.

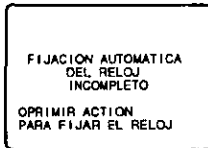

Presione ACTION para exhibir la pantalla "FIJAR RELOJ" (manual), y luego realice los pasos B y C en la página 41.

Notas:

Si ud. usa una caja de TV por cable y recibe emisiones de más de un canal PBS, ud. debe salir desde la pantalla de la fijación del reloj manual e intente fijar automáticamente otravez. Siga la "Para fijar o fijar de nuevo el reloj" en la página 42 y cuando las instrucciones de la pantalla requiere la fijación del canal PBS, fije un canal que no ha intentado anteriormente.



- La fijación automática de la hora se efectuará cada día al apagar la grabadora por primera vez. Si ud. usa una caja de TV por cable y desea efectuar la fijación automática de la hora, la caja de TV por cable debe permanecer encendido y sintonizado al canal PBS cuando la grabadora se apaga.

Instrucciones alternativas

Complete los siguientes pasos si ha efectuado una de las siguientes explicaciones.

- Ud. ha elegido la segunda conexión (VCR▶CABLE/ DSS▶TV o VCR▶TV) en el paso 4 de la página 40.
- Ud. ha elegido "SIN CONTROL REMOTO" en el paso 6 de la página 40 (su caja de TV por cable o receptor DSS no tiene un control remoto).
- Ud. está usando un receptor DSS y ha elegido "SI" en el paso 8 de la página 40.

1 Encienda la caja de TV por cable y fije la caja de TV por cable al canal PBS de su local.

- Si ud. vive cerca de una zona con diferente hora, asegúrese de fijar el canal de su zona.
- Si ud. usa un receptor DSS, éste debe estar apagado.

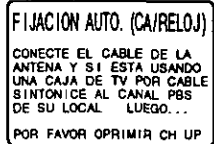

2 Oprimir CH ▲ para iniciar la fijación automática de los canales y la fijación de la hora.

- Aparece las siguientes informaciones: "AUTOPROGRAMACION EN PROCESO" "FIJACION AUTOMATICA DEL RELOJ EN PROCESO"

Esta pantalla aparece para informarle que la fijación automática de la hora es incompleto.

3 Comprobar si la hora está fijada correctamente y luego oprimir CH ▲ para terminar la fijación.

Si aparece esta pantalla, la fijación automática no es disponible en su zona. Ajuste el reloj a mano tal como se describe a continuación.

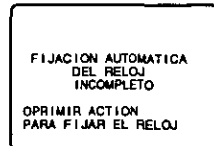
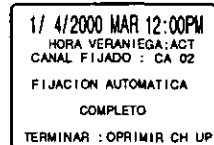

A Oprimir ACTION para que aparezca la pantalla de la fijación del reloj.

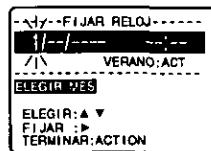

B Oprimir ▲▼ y ◀▶ para elegir y fijar el mes, la fecha, el año, la hora y la hora veraniega.

Para hacer correcciones Oprimir ◀▶ sucesivamente para avanzar o para retroceder hasta el paso que desea corregir.

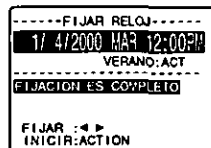

C Oprimir ACTION dos veces para iniciar a funcionar el reloj y salir desde este modo.

Si la hora y la hora veraniega es incorrecta, Raras veces, en caso de que ud. vive cerca de dos zonas con hora diferente, el aparato puede elegir un canal PBS con diferente hora de su zona. En este caso, haga los siguientes pasos:

- Tome nota del canal que está fijado en la pantalla y salga desde este modo oprimiendo el botón CH ▲.
- Anule este canal desde los canales memorizados en la combinación de VCR/TV.
- Oprimir el botón ACTION para que aparezca la pantalla del ACTION.
- Oprimir ▲▼ para elegir "FIJAR RELOJ" y luego oprimir ► para que aparezca la pantalla de "FIJAR RELOJ."
- Oprimir ▲▼ para elegir y fijar "FIJACION AUTOMATICA".
- Siga las instrucciones en la páginas 40 y 41.
 - Si ud. esta usando una caja de TV por cable y tiene muchos canales PBS, sintonize la caja de TV por cable a un canal PBS diferente e intente la fijación automática otravez.

Operaciones básicas para la reproducción

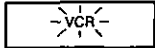
- Introducir una cinta
 - Esta indicación aparece en la pantalla multifuncional. 
- Oprimir PLAY en el control remoto o en la videograbadora para comenzar a reproducir.
 - Si la cinta no tiene la lengüeta para evitar el borrado la videograbadora comienza a reproducir automáticamente.
- Oprimir STOP en el control remoto o en la videograbadora para parar la reproducción.
- Oprimir EJECT en el control remoto o en la videograbadora para expulsar la cinta.
 - Usted puede expulsar la cinta cuando el aparato está encendido o apagado.

Para fijar o fijar de nuevo el reloj

En caso de que el reloj es incorrecto o ha ocurrido un corte eléctrico.

- Oprimir ACTION para que aparezca la pantalla del menú.
- Oprimir ▲▼ para elegir "FIJAR RELOJ" y luego oprimir ► para que aparezca la pantalla de "FIJAR RELOJ."
- Oprimir ▲▼ para elegir "MANUAL," y luego oprimir ► para que aparezca la pantalla de la fijacion del reloj.
- Oprimir ▲▼ y ◀▶ para elegir y fijar la hora y la fecha.
- Oprimir ACTION dos veces para iniciar a funcionar el reloj y salir desde este modo.

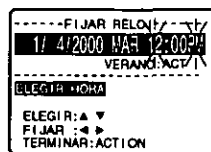
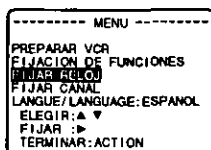

- Para ajustar el reloj automático, seleccione "FIJACION AUTOMATICA" y luego siga las instrucciones de ajuste de una vez del videograbador en las páginas 40 y 41.

Operaciones básicas para la grabación

1 Introducir una cinta con la lengüeta.

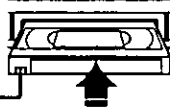

- La videograbadora se enciende automáticamente.

2 Oprimir CH ▲▼ o las teclas numéricas para elegir un canal.

- U oprimir CH ▲▼ en la videograbadora.
- Manteniendo presionado CH ▲▼ se aumentará la velocidad de búsqueda de canal.
- Para grabar desde una fuente externa, oprimir CH ▲▼ o INPUT para elegir "LINEA1" o "LINEA2."

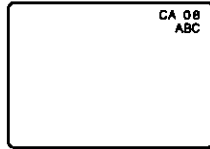

3 Oprimir SPEED para cambiar la velocidad de la cinta.

- SP = Reproducción estándar,
- LP = Larga duración,
- SLP = Superlarga duración.



4 Oprimir REC/TIME en el control remoto o videograbadora para empezar a grabar.

- Oprimir PAUSE para hacer una pausa en la grabación en progreso. Para continuar, vuelva a presionar PAUSE. (Después que el videograbador se encuentre en el modo de pausa durante 5 minutos, se detendrá automáticamente para proteger la cinta y los cabezales de video.)

Grabación de un toque (OTR)

La videograbadora termina la grabación a una hora programada. En el paso 4, oprimir repetidamente REC/TIME para fijar el tiempo de grabación. Cada presión cambiará la hora de parada como demuestra al siguiente.

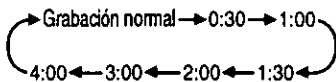

5 Oprimir STOP para parar la grabación.

O, presione STOP/EJECT en el videograbador.

Programación fácil para la grabación con temporizador

1 Oprimir PROG para que aparezca la pantalla "FIJAR PROGRAMACION."



2 Oprimir ▲▼ para elegir "TEMPORIZADOR" y luego oprimir ► para exhibir la pantalla de la programación.

- Si ya existe una programación memorizada, oprimir ▲▼ y ► para elegir un número sin programación.

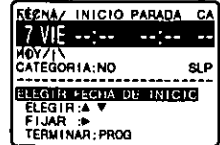

3 Oprimir ▲▼ y ► para elegir y fijar uno de los siguientes:

- 1-31 = Grabación de una sola vez
- DIARIO = A una misma hora LUN-VIE
- SEMANAL = Una vez a la semana a una misma hora

Ejemplo

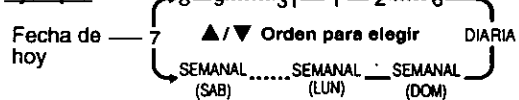

4 Oprimir ▲▼ y ◀▶ para elegir y fijar las siguientes fijaciones.

Fijaciones:

- Hora de inicio
- Hora de parada
- Canal o LINEA para una fuente externa
- Categoría (NO, DEPORTE, CINE, COMEDIA, MUSICA, DRAMA)
- Velocidad de la cinta (SP, LP, SLP).

Para hacer correcciones

Oprimir ► sucesivamente para avanzar u ◀ para retroceder hasta el paso que desea corregir.

5 Oprimir PROG para terminar la programación.

- Esta pantalla aparece para confirmación.

Si usa un receptor DSS y fija un canal de 100-125, aparecerá la pantalla a la derecha.

Oprimir ▲▼ para elegir "DSS" o "CABLE" y luego oprimir ► para fijar.

- La pantalla para la confirmación como demuestra arriba aparecerá luego de la fijación.

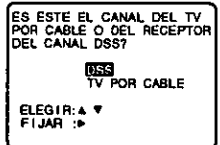
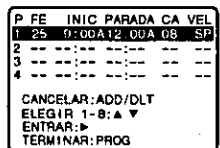

Para hacer más programaciones

Oprimir ▲▼ y ► para elegir y fijar un número de programación en blanco y luego repita los pasos 3 y 4.

6 Oprimir PROG para salir desde este modo y volver a la pantalla normal.

7 Oprimir POWER y apague el aparato para la grabación con temporizador.



Pantalla multifuncional

- Si la fuente de la grabación es una caja de TV por cable, asegúrese de que la caja de TV por cable esté encendido y esté sintonizado al canal que desea grabar.

Quick Use Guide

This guide should only be used once you are familiar with the operations inside this manual. If you have any problems or need more information, please refer to the page listed.

Clock Reset (page 17)

Display the menu

```

  ----- MENU -----
  SET UP VCR
  SET UP FEATURE
  SET CLOCK
  SET UP CHANNEL
  ID IOMA / LANGUAGE: ENGLISH
  SELECT: ▲ ▼ KEY
  SET : ► ◄ KEY
  END : ACTION KEY
  
```

Select "SET CLOCK"

```

  ----- SET CLOCK -----
  AUTO CLOCK SET
  MANUAL
  SELECT: ▲ ▼ KEY
  SET : ► ◄ KEY
  END : ACTION KEY
  
```

Select "MANUAL"

```

  ----- SET CLOCK -----
  1/ 4/2000 TUE 12:00PM
  SET: ON
  SELECT: ► ◄ KEY
  SET : ▲ ▼ KEY
  END : ACTION KEY
  
```

Set the clock

Start the clock & exit this mode

Playback a Tape (page 19)

Turn TV on
Select VCR
Channel 3/4

Insert a tape

Start playback

Stop playback

Eject tape

Make a Recording (page 20)

Turn TV on
Select VCR
Channel 3/4

Insert a tape
with Record Tab

Select channel

Select speed

Start recording

Stop recording

Set a Timer Recording (page 22)

Display the program screen

```

  ----- SET PROGRAM -----
  VCR P.N. PROGRAM
  TIMER PROGRAM
  SELECT: ▲ ▼ KEY
  SET : ► ◄ KEY
  END : PROG KEY
  
```

Select "TIMER PROGRAM"

```

  DATE / START STOP CH
  7 FRI  ---  ---  ---
  7 DAY  CATEGORY: N/A  SLP
  -----
  SELECT: START DATE
  SELECT: ▲ ▼ KEY
  SET : ► ◄ KEY
  END : PROG KEY
  
```

Enter timer information

```

  P DT START STOP CH SPD
  1 DAY 9 00A12:00A 08 SP
  2
  3
  4
  -----
  CANCEL: ADD/HLT KEY
  SELECT 1-8: ▲ ▼ KEY
  ENTER : ► KEY
  END : PROG KEY
  
```

Once to finish the program,
twice to exit this mode

Turn VCR off
to set the timer

Panasonic Consumer Electronics Company, Division of Matsushita Electric Corporation of America
One Panasonic Way Secaucus, New Jersey 07094

Panasonic Sales Company, Division of Matsushita Electric of Puerto Rico, Inc. ("PSC")
Ave. 65 de Infantería. Km. 9.5 San Gabriel Industrial Park, Carolina, Puerto Rico 00985

